



TRX 特锐祥
专注电容器材料

	SMD- 1 SMD 1 . .		
	/N		/D
	/E		/P



SM 1		S . .	
/N		/D	
/E		/P	

1. /P N

T G 1 102 K

2. /P

--	--

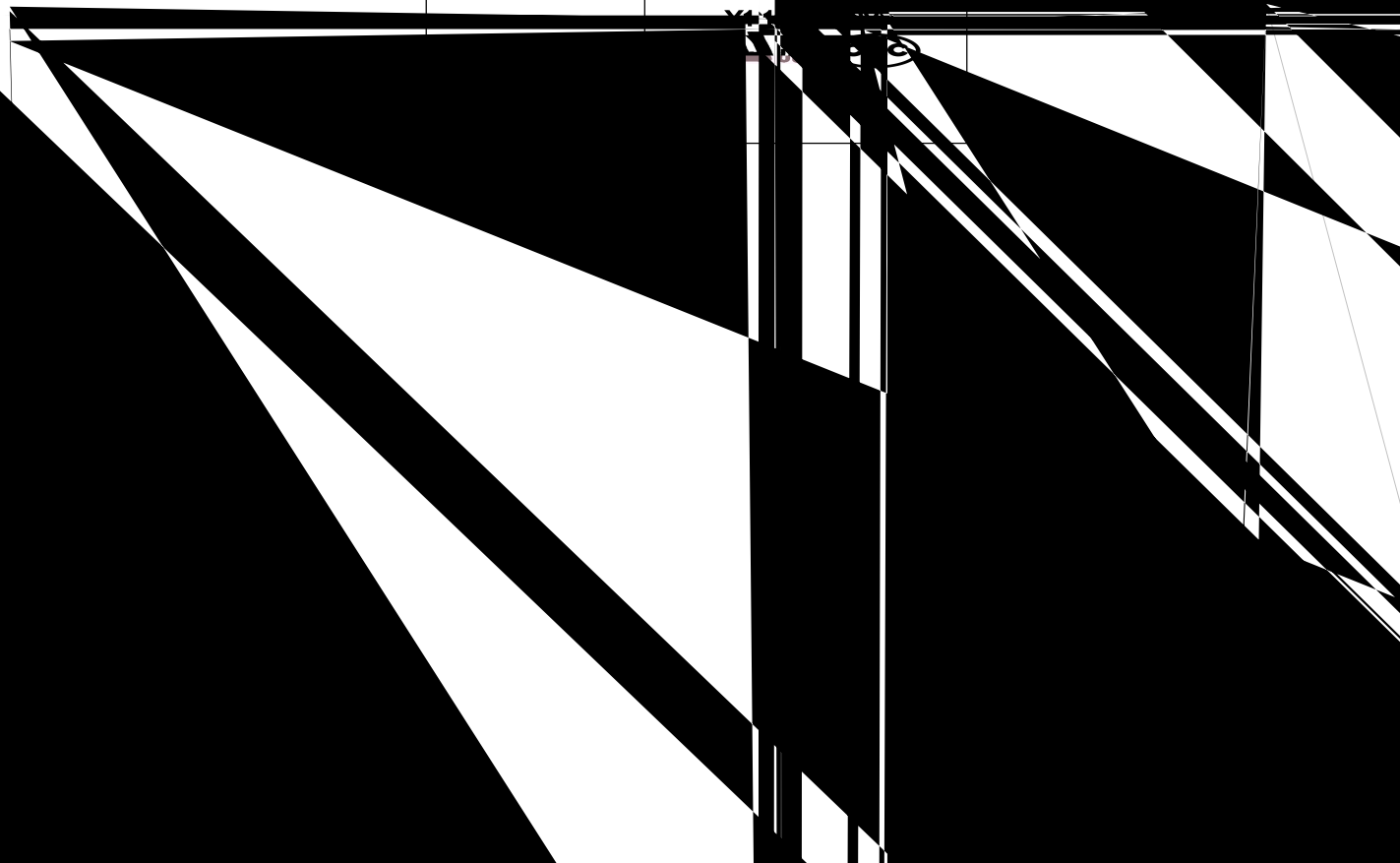



/N

SMD- 1
SMD 1 . .

	SMD- 1 SMD 1 . .		
	/N		/D
	/E		/P

/

/

7. /P



SMD- 1
SMD 1 . .

/N

/D

/E

/P

±

 TRX 专注电容器廿年	SMD- 1		
	SMD 1 . .		
	/N		/D
/E		/P	

			± ±
			± ±
			± ±
			± ±
			± ±
			± ±
			± ±
			± ±
			± ±

8. /C

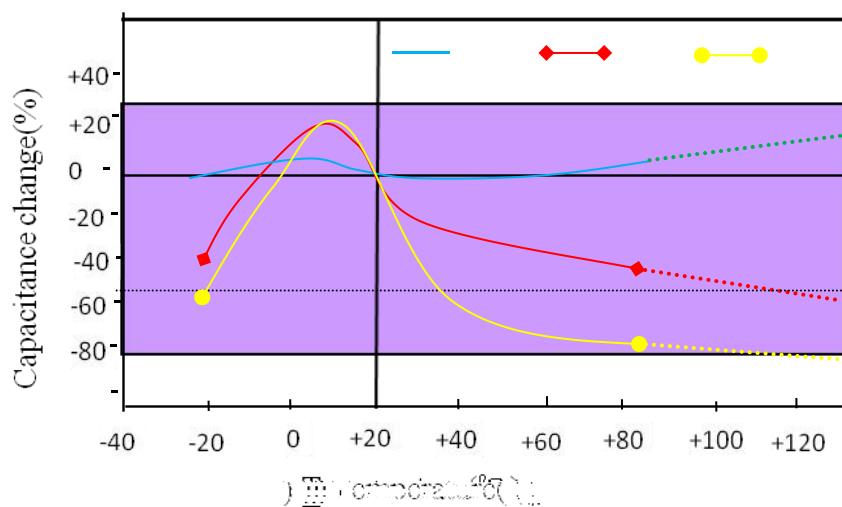

11. /P

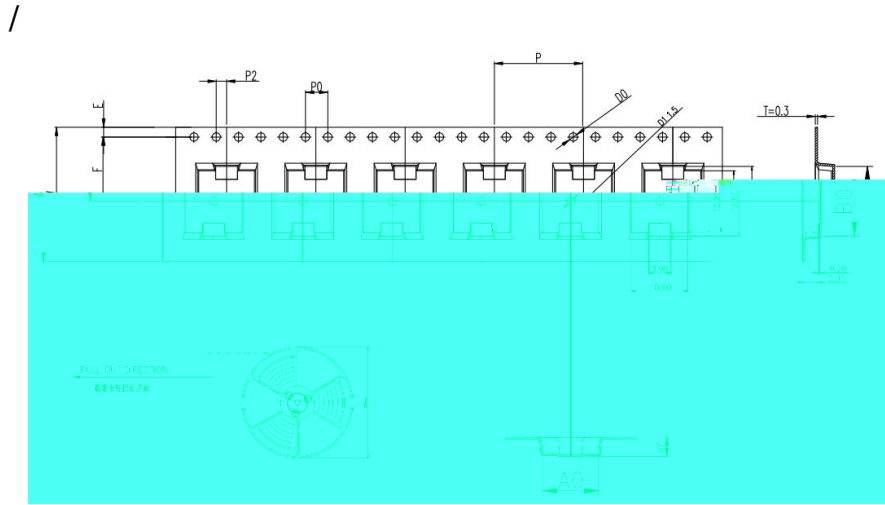

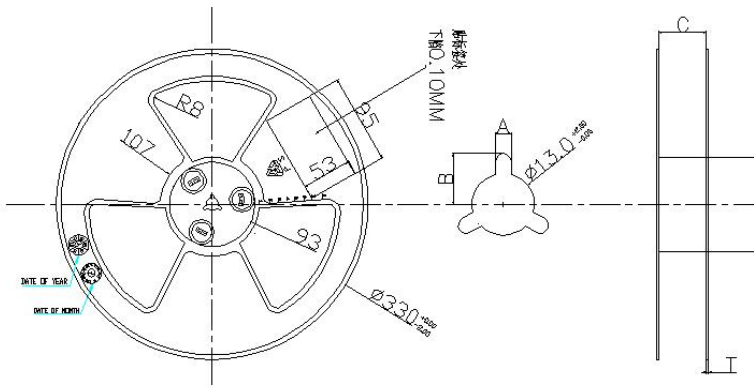

ITEM	W	A0	B0	K1	K0	P	F	E	D0	D1	P0	P2	T											
DIM	24.0	$^{+0.30}_{-0.30}$	$^{+0.10}_{-0.10}$	$^{+0.10}_{-0.10}$	$^{+0.10}_{-0.10}$	3.45	$^{+0.10}_{-0.10}$	16.0	$^{+0.10}_{-0.10}$	11.50	$^{+0.10}_{-0.10}$	1.75	$^{+0.10}_{-0.10}$	$\varnothing 1.5$	$^{+0.10}_{-0.00}$	$\varnothing 1.5$	$^{+0.10}_{-0.00}$	4.0	$^{+0.10}_{-0.10}$	2.0	$^{+0.10}_{-0.10}$	0.30	$^{+0.05}_{-0.05}$	
ALTERNATE																								

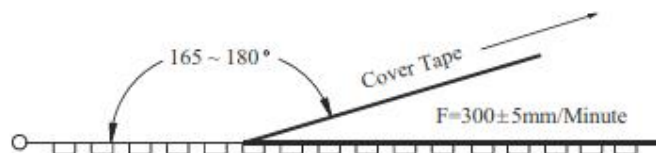

SPEC	A±0.3	B±0.5	C $^{+0.5}_{-0.0}$	D±0.5	T±0.2
24	2.3	10.75	24.4	Ø97	2.2

Item	Data	Remark
Cover tape adhesion	10 ~ 100g	Carrier tape and cover tape open angle 165 ~ 180° F=300± 5mm/minute



 TRX 专注电容器廿年	SMD- 1		
	SMD 1 . .		
	/N		/D
		/P	

/ -





TRX 特锐祥
TGY1102K







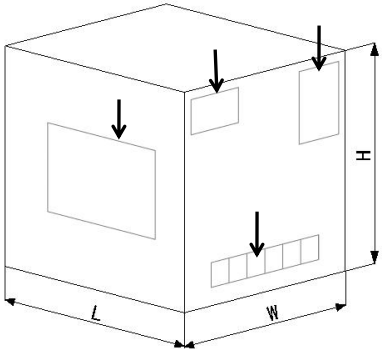

/O -













/P :









" "

R

