



IGBT Discrete

V_{CE}	650	V
I_C	50	A
$V_{CE(SAT)}$ $I_C=50A$	1.60	V

Applications

High frequency switching application
Resonant converters
Uninterruptible power supply
Welding converters

Features

High speed smooth switching device for hard & soft switching
Maximum junction temperature 175
Positive temperature coefficient
High ruggedness, temperature stable
Pb-free lead plating; RoHS compliant

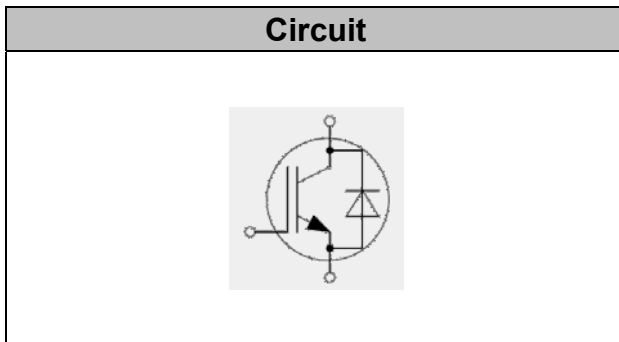

■Maximum Ratings

Parameter	Symbol	Value	Unit
Collector-Emitter Breakdown Voltage	V_{CE}	650	V
DC Collector Current, limited by T_{jmax} $T_C=25^{\circ}C$ value limited by bondwire $T_C= 100^{\circ}C$	I_C	85 60	A
Diode Forward Current, limited by T_{jmax} $T_C= 25^{\circ}C$ value limited by bondwire $T_C= 100^{\circ}C$	I_F	85 60	A
Continuous Gate-Emitter Voltage	V_{GE}	± 20	V
Transient Gate-Emitter Voltage ($t_p \le 10\mu s, D < 0.010$)	V_{GE}	± 30	V
Turn off Safe Operating Area $V_{CE} 650V,$ $T_j 150^{\circ}C$		200	A
Pulsed Collector Current, $V_{GE}=15V,$ t_p limited by T_{jmax}	I_{CM}	200	A
Diode Pulsed Current, t_p limited by T_{jmax}	I_{Fpuls}	200	A
Power Dissipation , $T_j=175^{\circ}C$, $T_C=25^{\circ}C$	P_{tot}	326	W
Operating Junction Temperature	T_j	- 40...+175	$^{\circ}C$
Storage Temperature	T_s	- 55...+150	$^{\circ}C$
Soldering Temperature, wave soldering 1.6mm (0.063in.) from case for 10s		260	$^{\circ}C$



DGW50N65CTL1

■ Electrical Characteristics of the IGBT $T_j = 25$ unless otherwise specified

Parameter	Symbol	Conditions	Min.	Typ.	Max.	Unit
Static						
Collector-Emitter Breakdown Voltage	BV_{CES}	$V_{GE}=0V, I_C=250\mu A$	650		-	V
Gate Threshold Voltage	$V_{GE(th)}$	$V_{GE}=V_{CE}, I_C=0.75mA$	4.25	5.05	5.85	V
Collector-Emitter Saturation Voltage	$V_{CE(sat)}$	$V_{GE}=15V, I_C=50A$ $T_j=25^\circ C,$ $T_j=125^\circ C$ $T_j=150^\circ C$	1.45	1.60 1.95 2.05	1.95	V
Zero Gate Voltage Collector Current	I_{CES}	$V_{CE}=650V, V_{GE}=0V$ $T_j=25^\circ C,$ $T_j=150^\circ C$			0.25 3.00	mA
Gate-Emitter Leakage Current	I_{GES}	$V_{CE}=0V, V_{GE}=20V$			200	nA

Parameter	Symbol	Conditions	Min.	Typ.	Max.	Unit
Dynamic						
Input Capacitance	C_{ies}	$V_{CE}=25V, V_{GE}=0V,$ $f=1MHz$	-	5.92	-	nF
Reverse Transfer Capacitance	C_{res}		-	0.23	-	
Gate Charge	Q_G	$V_{CC}=300V, I_C=50A, V_{GE}=15V$	-	0.45	-	μC



DGW50N65CTL1

■Switching Characteristic, Inductive Load

Parameter	Symbol	Conditions	Min.	Typ.	Max.	Unit
Dynamic , at T_j= 25°C						
Turn-on Delay Time	t _{d(on)}	V _{CC} =300V, I _C =50A, V _{GE} = 0v~15V, R _g =10 ,L _s =60nH	-	55	-	ns
Rise Time	t _r		-	56	-	ns
Turn-on Energy	E _{on}		-	1.27	-	mJ
Turn-off Delay Time	t _{d(off)}		-	319	-	ns
Fall Time	t _f		-	24	-	ns
Turn-off Energy	E _{off}		-	0.65	-	mJ
Total switching energy	E _{ts}				1.92	
Dynamic , at T_j= 125°C						
Turn-on Delay Time	t _{d(on)}	V _{CC} =300V, I _C =50A, V _{GE} = 0v~15V, R _g =10 ,L _s =60nH	-	53	-	ns
Rise Time	t _r		-	61	-	ns
Turn-on Energy	E _{on}		-	1.51	-	mJ
Turn-off Delay Time	t _{d(off)}		-	351	-	ns
Fall Time	t _f		-	59	-	ns
Turn-off Energy	E _{off}		-	0.80	-	mJ
Total switching energy	E _{ts}				2.31	
Dynamic , at T_j= 150°C						
Turn-on Delay Time	t _{d(on)}	V _{CC} =300V, I _C =50A, V _{GE} = 0v~15V, R _g =10 ,L _s =60nH	-	52	-	ns
Rise Time	t _r		-	60	-	ns
Turn-on Energy	E _{on}		-	1.62	-	mJ
Turn-off Delay Time	t _{d(off)}		-	361	-	ns
Fall Time	t _f		-	71	-	ns
Turn-off Energy	E _{off}		-	0.85	-	mJ
Total switching energy	E _{ts}				2.47	



DGW50N65CTL1

■Electrical Characteristics of the Diode $T_j=25$ unless otherwise specified

Parameter	Symbol	Conditions	Min.	Typ.	Max.	Unit
Static						
Diode Forward Voltage	V_F	$I_F=50A$ $T_j=25^{\circ}C,$ $T_j=125^{\circ}C$ $T_j=150^{\circ}C$	1.30	1.45 1.29 1.23	1.80	V

■Electrical Characteristics of the DIODE

Parameter	Symbol	Conditions	Min.	Typ.	Max.	Unit
Dynamic , at $T_j=25^{\circ}C$						
Reverse Recovery Current	I_{rr}	$I_F=50A, V_R=300V$ $-di/dt=610A/\mu s,$	-	13	-	A
Reverse Recovery Charge	Q_{rr}		-	0.78	-	μC
Diode reverse recovery time	t_{rr}		-	100	-	ns
Reverse Recovery Energy	E_{rec}		-	0.1	-	mJ
Dynamic , at $T_j=125^{\circ}C$						
Reverse Recovery Current	I_{rr}	$I_F=50A, V_R=300V$ $-di/dt=610A/\mu s,$	-	35	-	A
Reverse Recovery Charge	Q_{rr}		-	2.8	-	μC
Diode reverse recovery time	t_{rr}		-	140	-	ns
Reverse Recovery Energy	E_{rec}		-	0.38	-	mJ
Dynamic , at $T_j=150^{\circ}C$						
Reverse Recovery Current	I_{rr}	$I_F=50A, V_R=300V$ $-di/dt=610A/\mu s,$	-	40	-	A
Reverse Recovery Charge	Q_{rr}		-	3.22	-	μC
Diode reverse recovery time	t_{rr}		-	160	-	ns
Reverse Recovery Energy	E_{rec}		-	0.43	-	mJ



DGW50N65CTL1

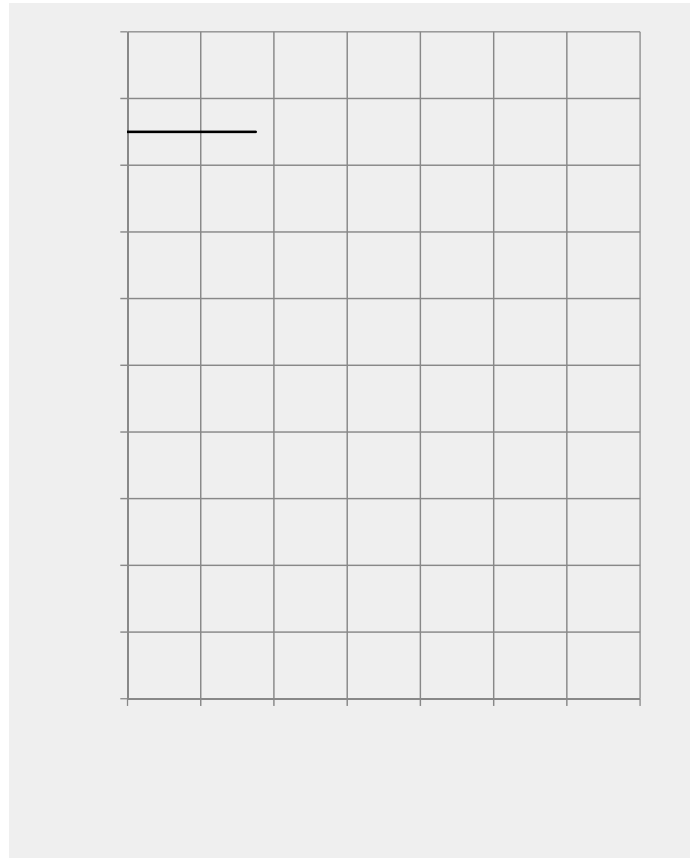
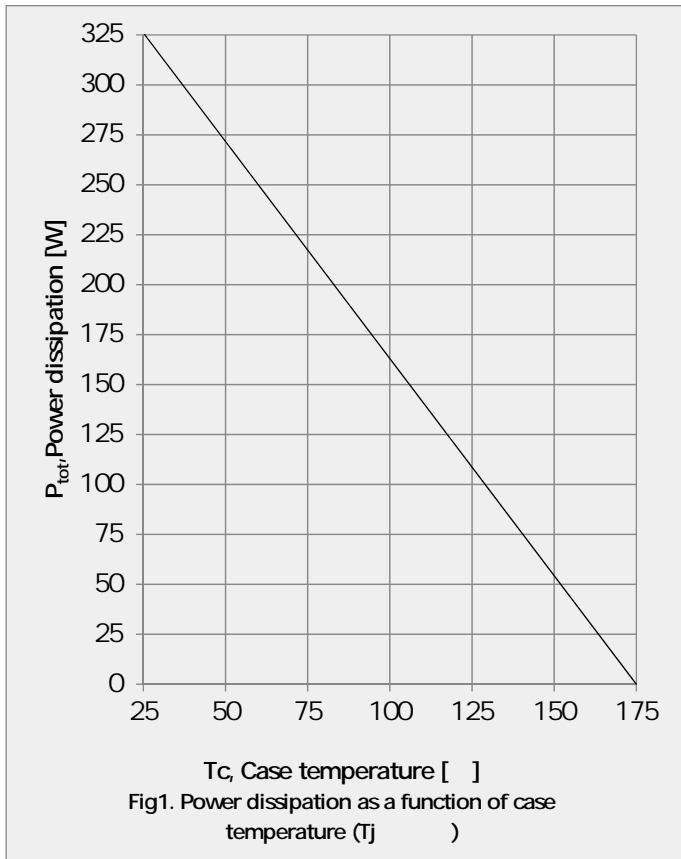



DGW50N65CTL1

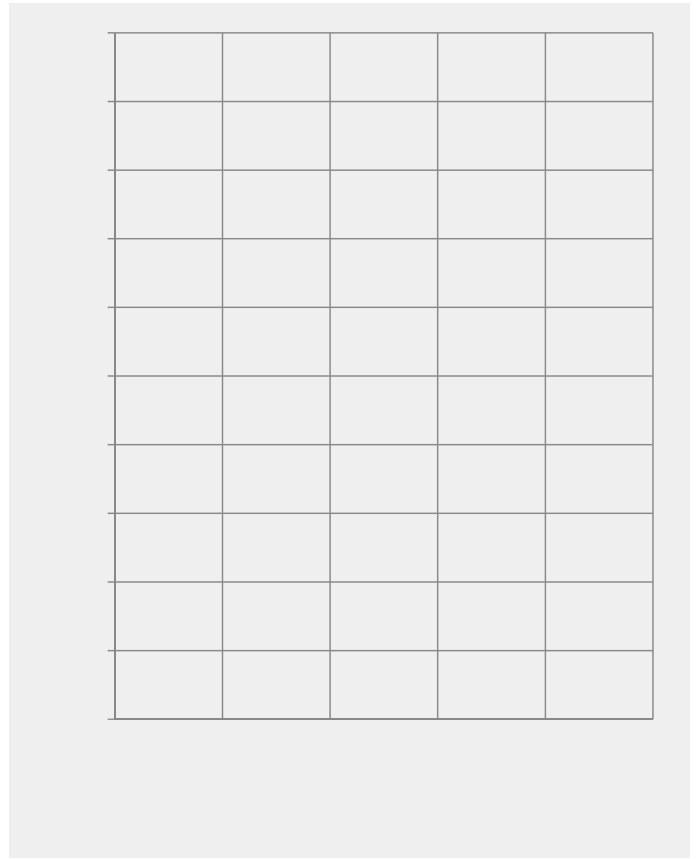
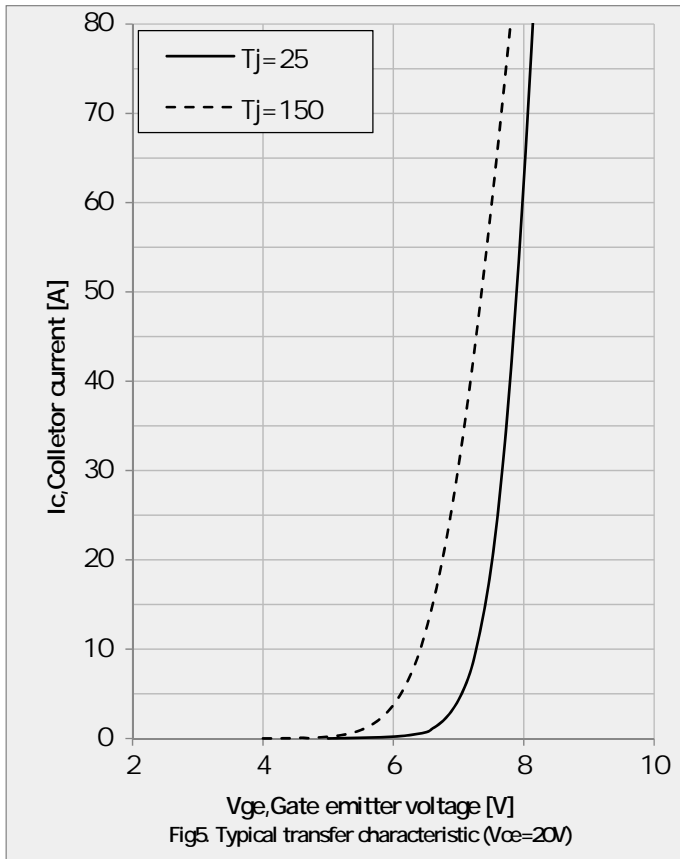



DGW50N65CTL1

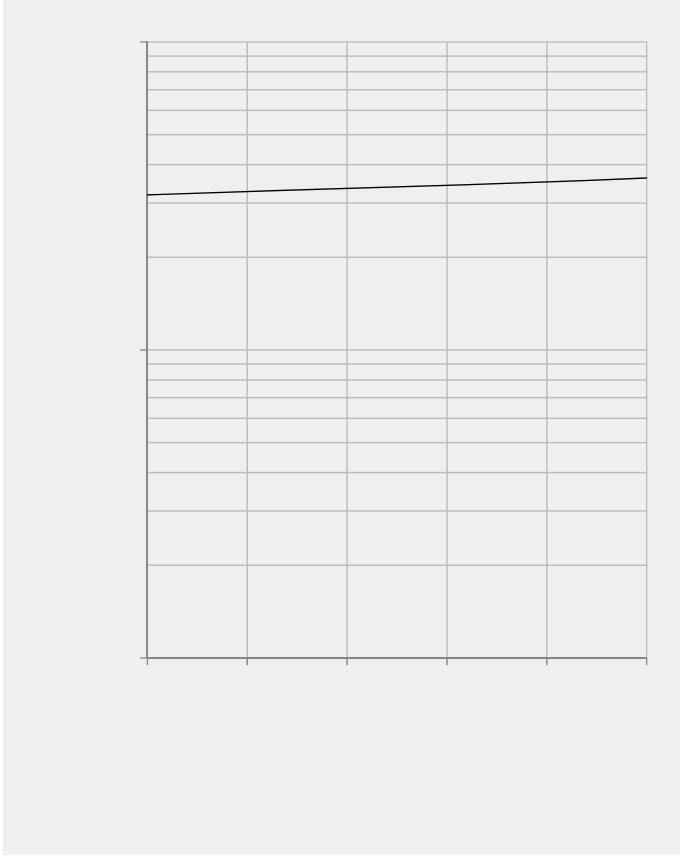



DGW50N65CTL1

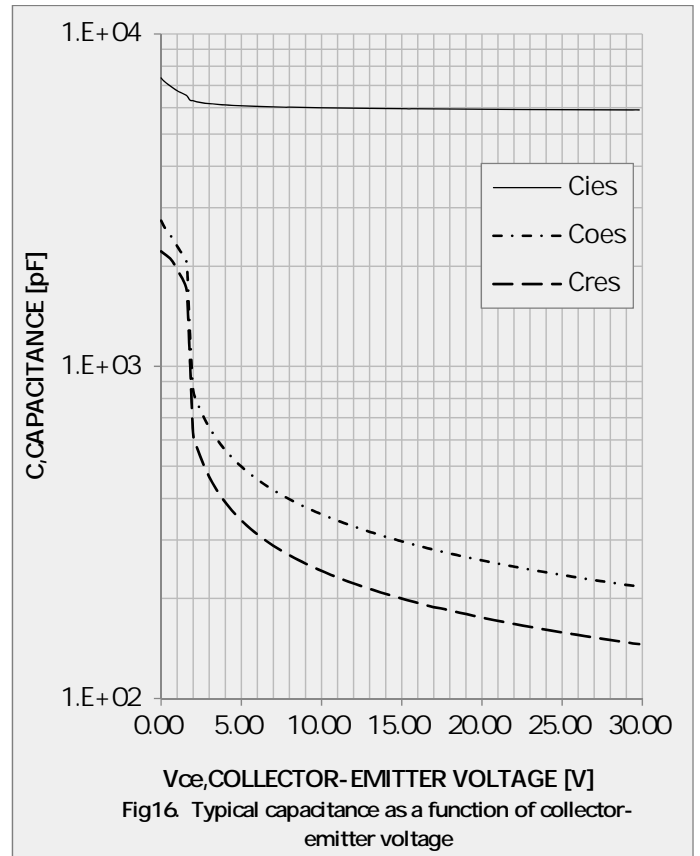
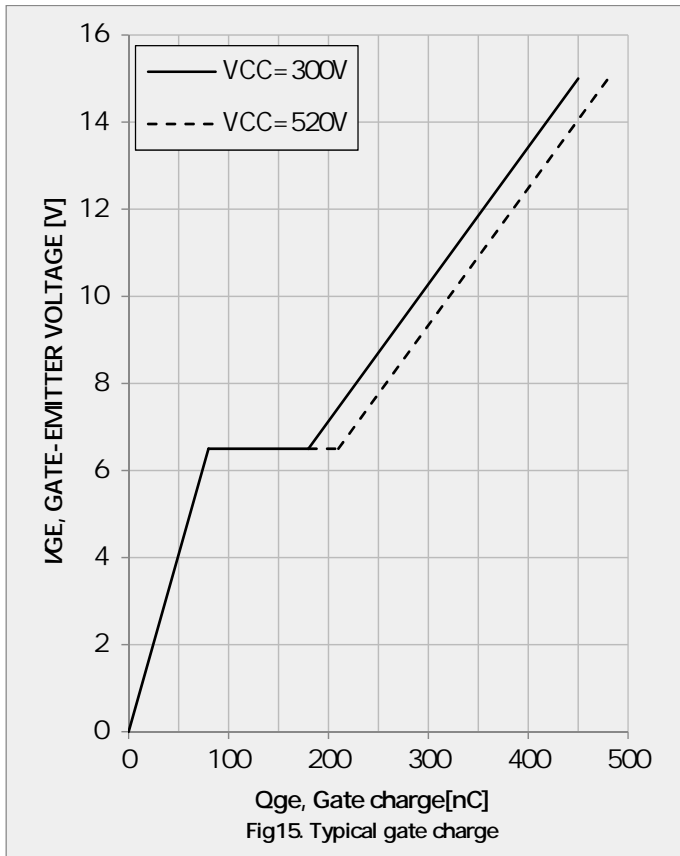
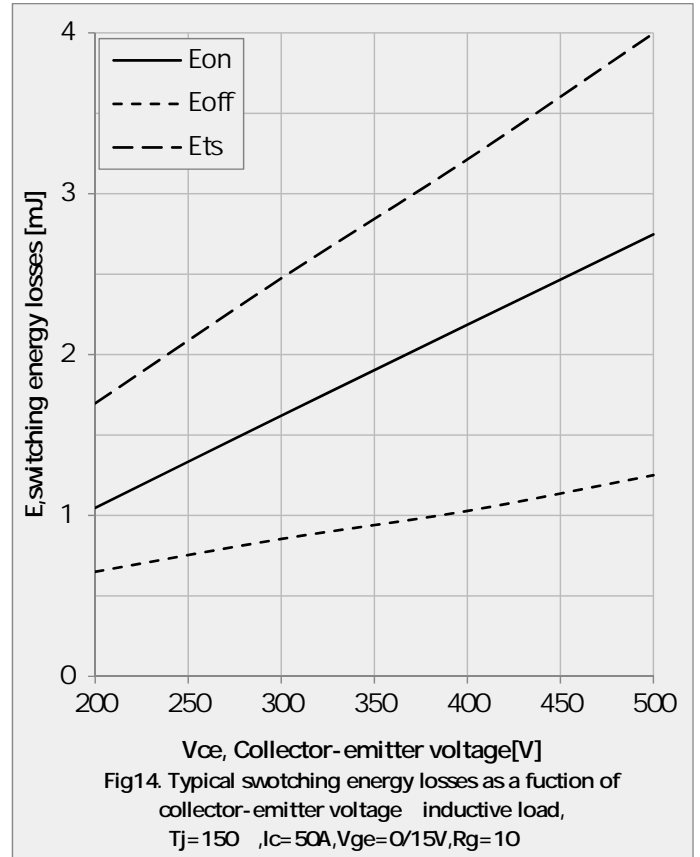
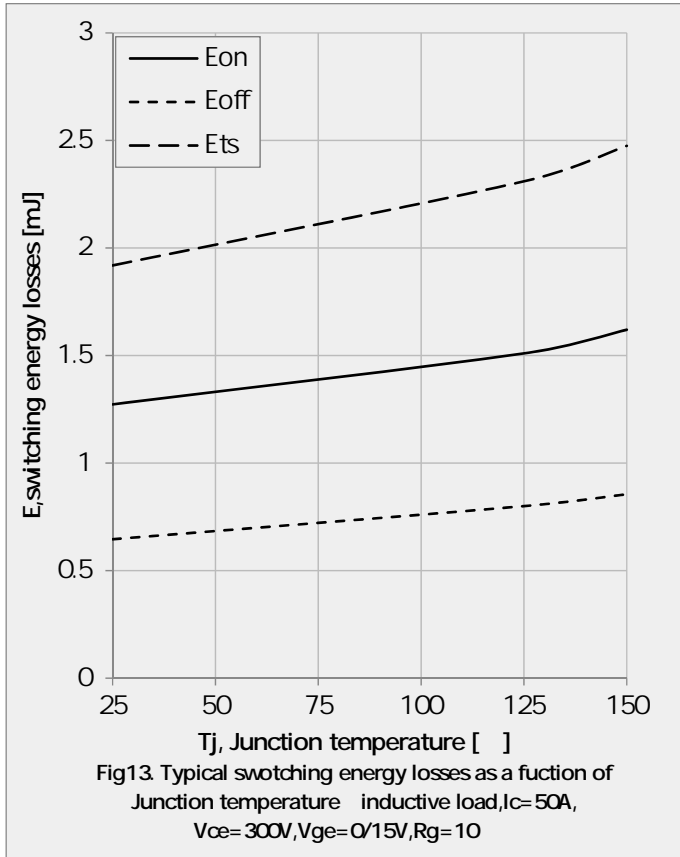



DGW50N65CTL1

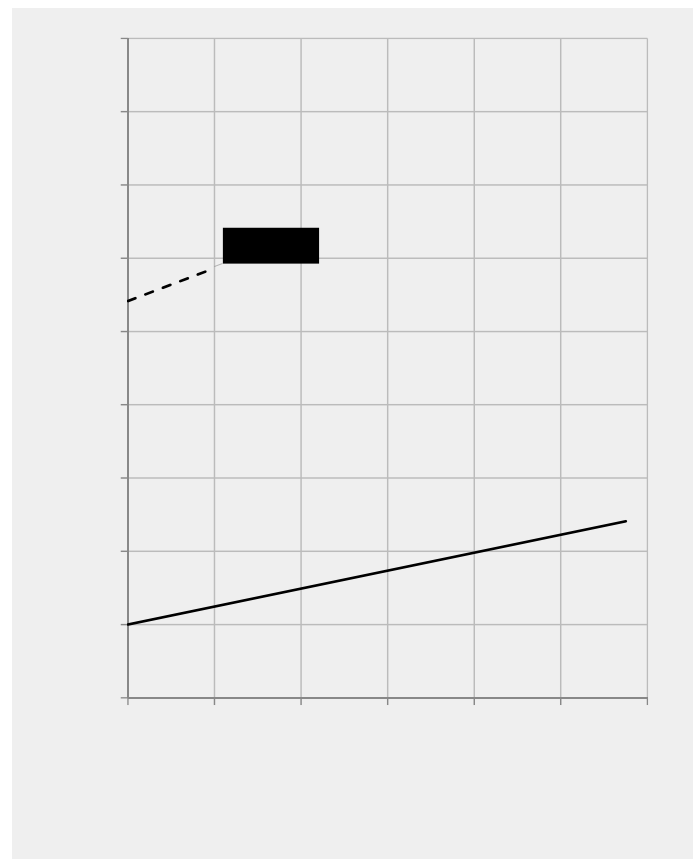
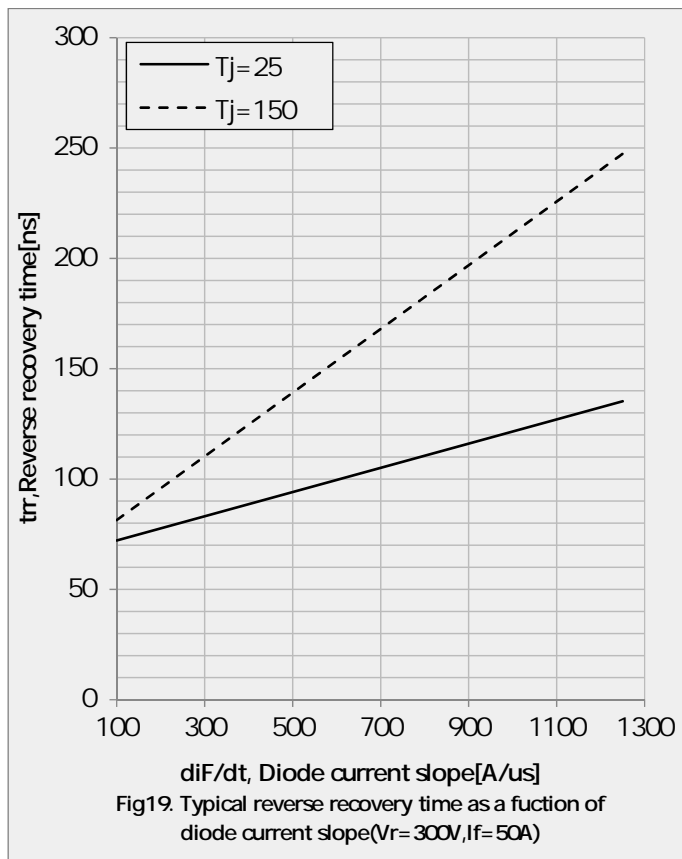
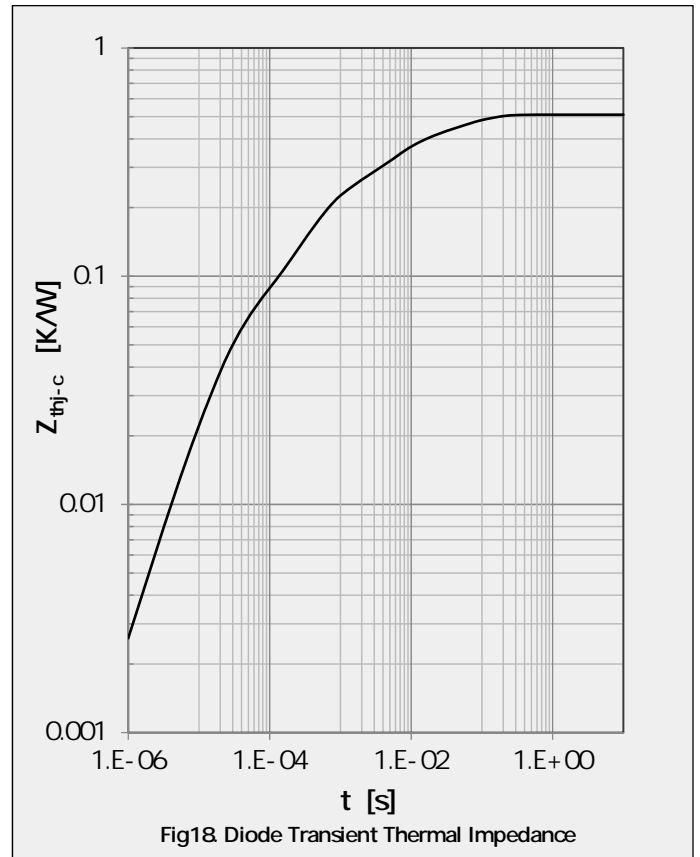
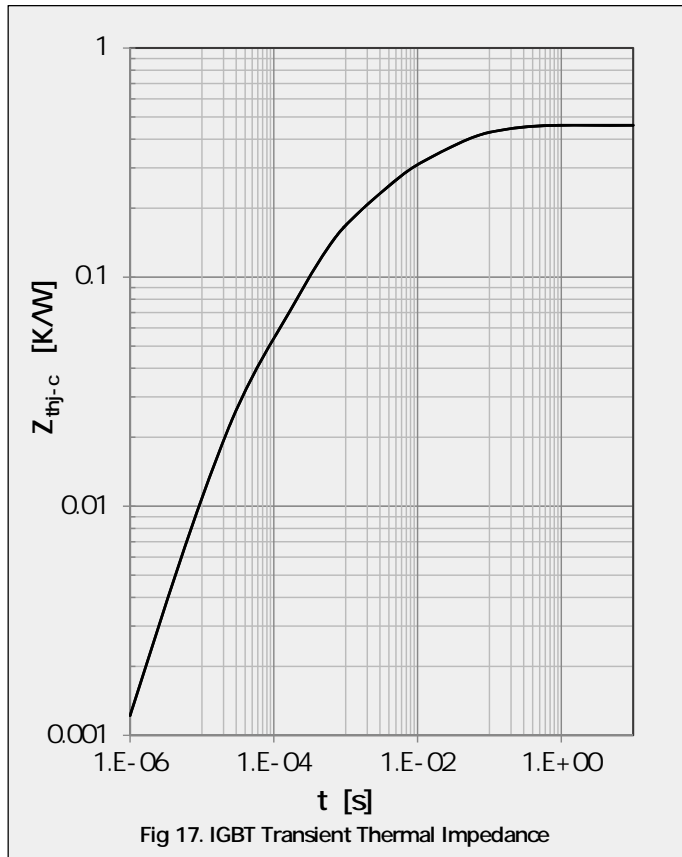



DGW50N65CTL1

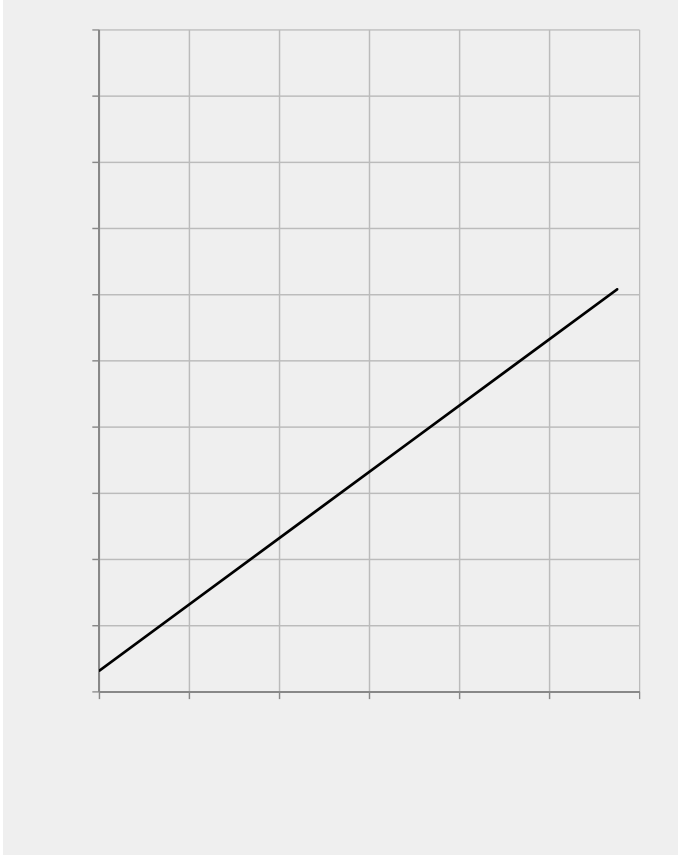



DGW50N65CTL1

■Circuit Diagram

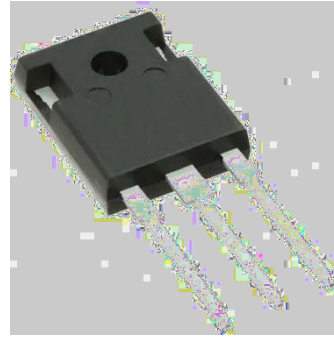
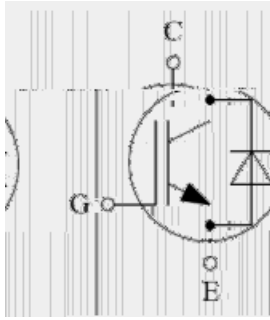

■Package Outline Information

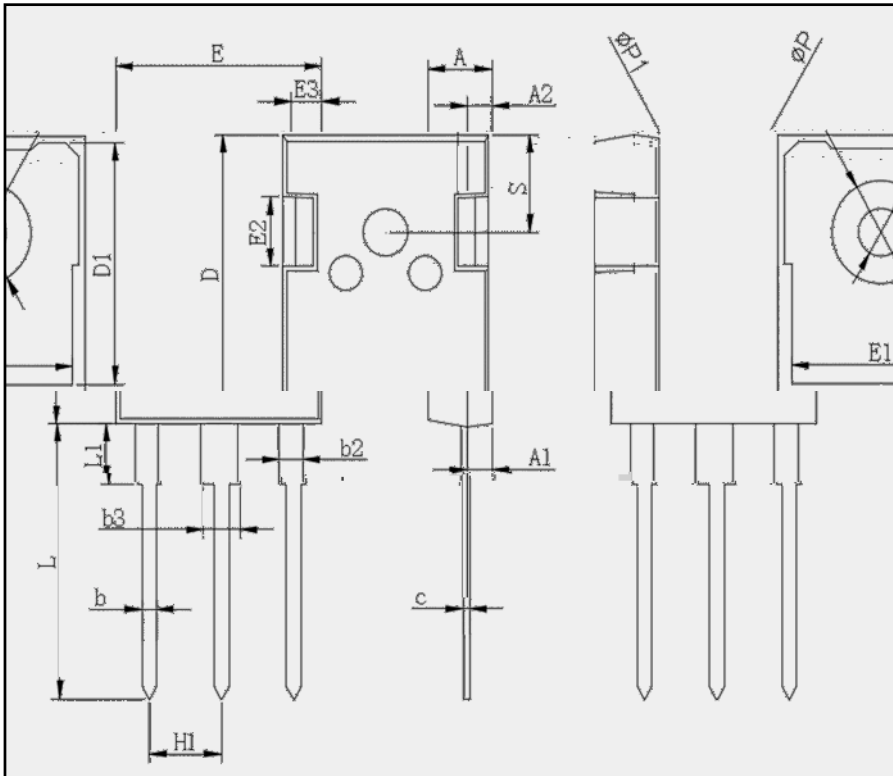

TO-247AB		
Dim	Min	Max
A	4.80	5.20
A1	2.21	2.61
A2	1.85	2.15
b	1.0	1.4
b2	1.91	2.21
C	0.5	0.7
D	20.70	21.30
D1	16.25	16.85
E	15.50	16.10
E1	13.0	13.6
E2	4.80	5.20
E3	2.30	2.70
L	19.62	20.22
L1	-	4.30
P	3.40	3.80
P1	-	7.30
S	6.15TYP	
H1	5.44TYP	
b3	2.80	3.20