

深圳市弗瑞鑫电子有限公司

规格承认书

—

prepare	
check	
approve	



TRX电容一级代理商
深圳市弗瑞鑫电子有限公司

深圳市宝安区西乡大道302号金源商务大厦B座301
 0755-29563634
 0755-27447020



/ . .			



/ . .

! /

!

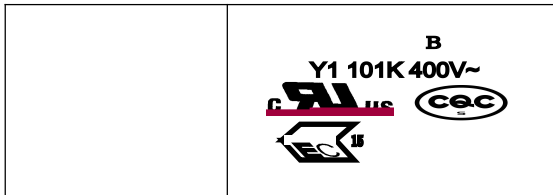

/ . .			

Product certification		environmental report	

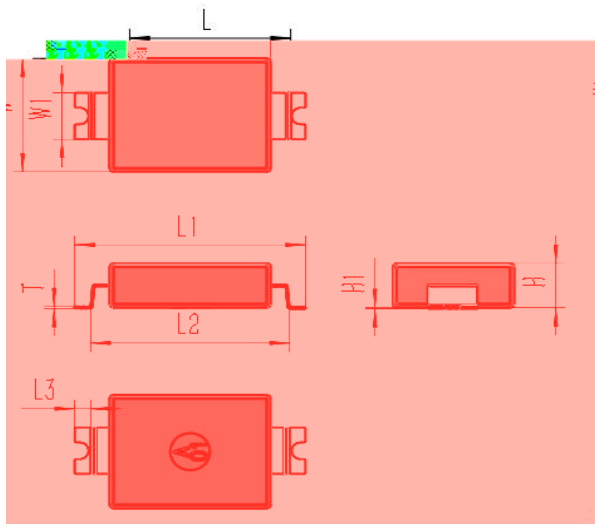

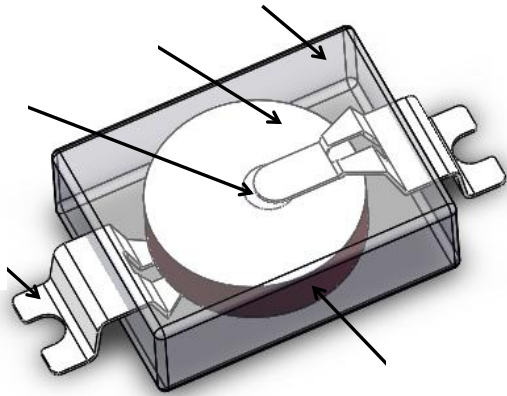

	/ . .			



.

.

.

.

-

. .

-

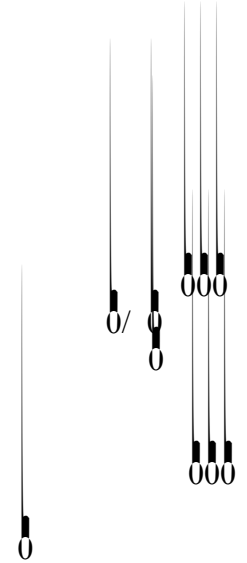

. .	000	00	0/0 0
	000		
.	0	,	.
0			0
		. .	+0-0. +0-0.
		% 0% 0% 0%	. 0.
		.0% . % . % . %	.
		. .	
.		0.	(0-0.) , 0-0. 0.
			.

					+
					-
()					



x]

.

.....

.....

/ . .			

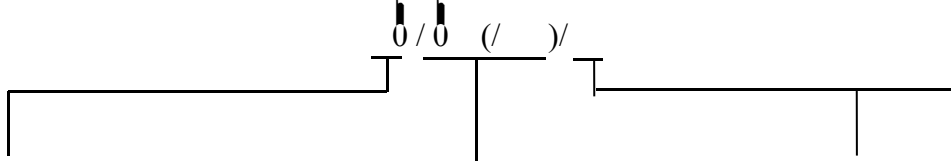

()
()
()

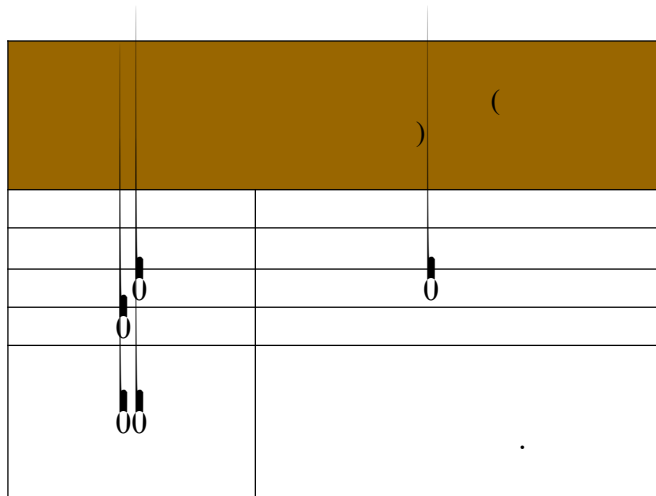
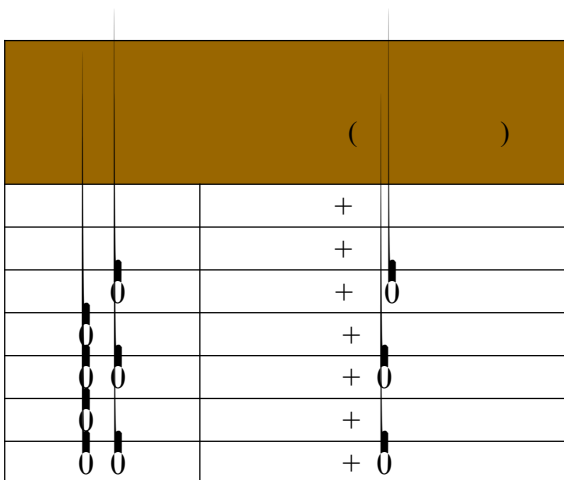
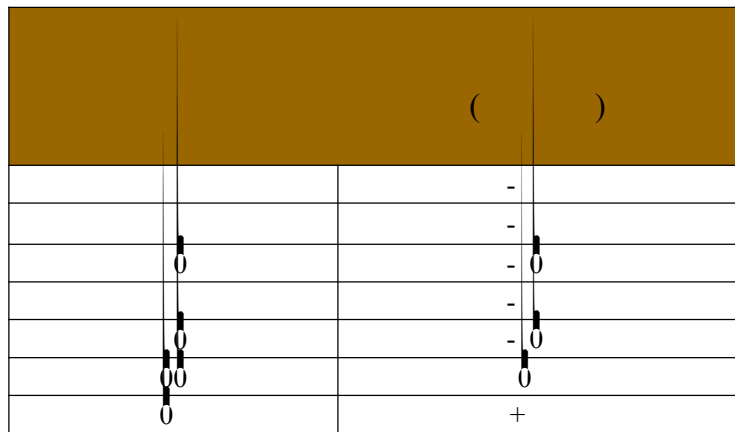
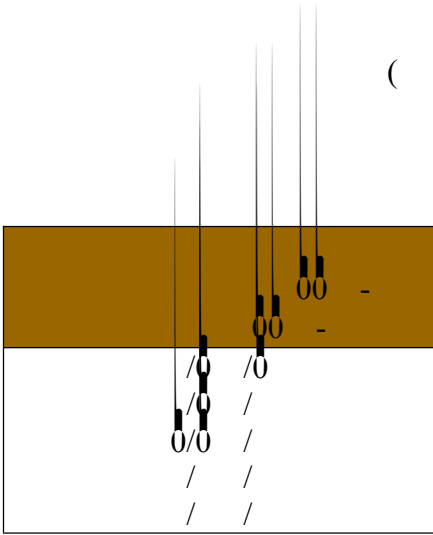

/ . .			

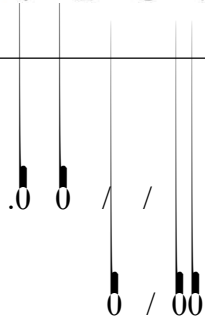

	()
	00
	000
	000
	000
	000
	000
+ + + + () + + +	00
	00
	00
+ +	00
()	000

	/ . .			



/ . .			

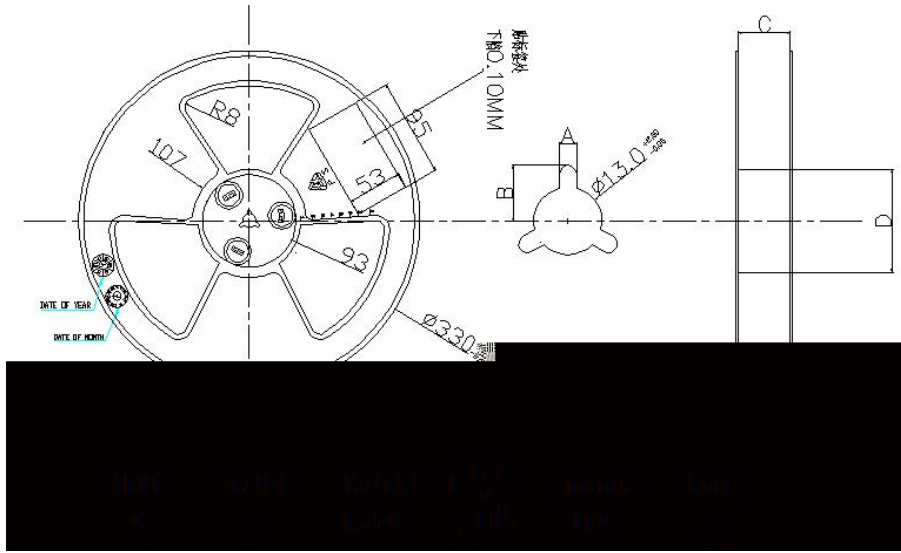
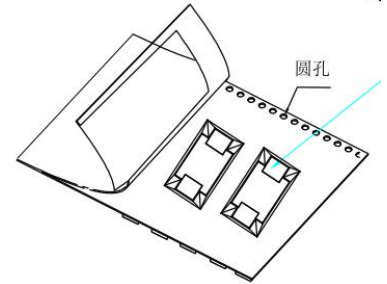
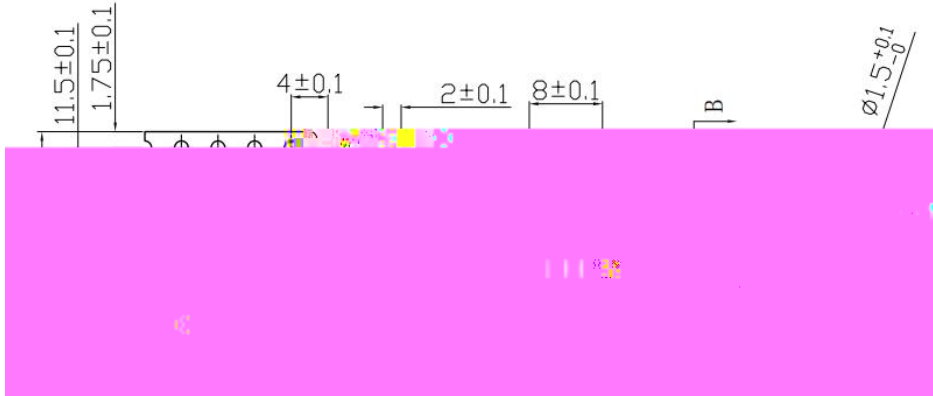

Item	Data	Remark
Cover tape adhesion	10 ~ 100g	Carrier tape and cover tape open angle 165 ~ 180° F=300± 5mm/minute

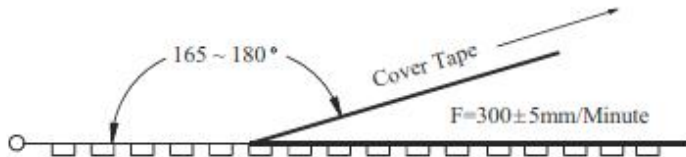

/ . .			

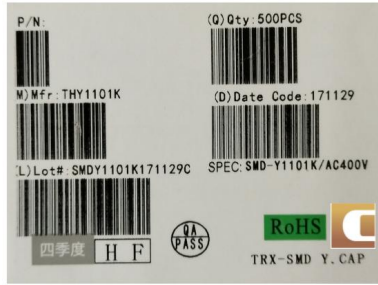

	/
	#

.0 /

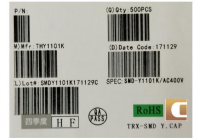
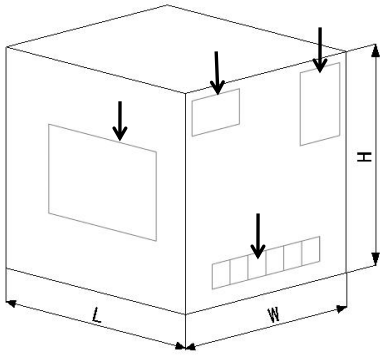

()				
			.0	.0



00* 00* 0 (/ /)



00* 00* 00

&

.0

/

.0

&

-

/

	/ . .			

..

-

.

..

..

.....

.

.

....

..

,



TRX 特锐祥

专 注 电 容 器 11 年

/ . .			

()



TRX 特锐祥

专 注 电 容 器 11 年

/ . .			

0 - 00

0 - 00

/ . - (0 - -)

/ - 00 (0 -)

/ . - 00 (-)

() -

()

/ - ()

/ - ()

/ - 00

/ - 00

/ - 00

0 / / (.0)

00 / / ()

/ / 00 / 0/ / / 0

0 / 00 () , , / / ()