



ORIENT

Photo coupler

Product Data Sheet

Part Number: OR-480

Customer: _____

Date: _____

一级代理商：

深圳市弗瑞鑫电子有限公司

地址：深圳市宝安区西乡大道302号金源商务大厦B座三楼

frxelec



1.

- (1) Performance Specified for Common IPM Applications Over Industrial Temperature Range.
- (2) Short Maximum Propagation Delays
- (3) Minimized Pulse Width Distortion (PWD)
- (4) Very High Common Mode Rejection (CMR)
- (5) Hysteresis
- (6) Totem Pole Output (No Pull-up Resistor Required)
- (7) Available in Stretched SO-6 package.
- (8) Industrial temperature range: -40° C to 105° C
- (9) Safety approval
 - UL approved(No.E323844)
 - VDE approved(No.40029733)
 - CQC approved (No.CQC19001231480)
- (10) In compliance with RoHS, REACH standard
- (11) MSL Level 1

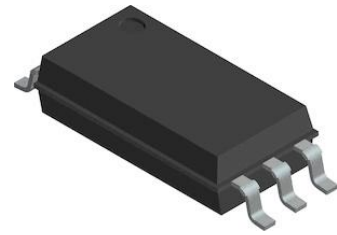

2.

The OR-480 fast speed optocou- plers contain a GaAsP LED and photo detector with built-in Schmitt trigger to provide logic-compatible waveforms, eliminating the need for additional wave shaping. The totem pole output eliminates the need for a pull up resistor and allows for direct drive Intelligent Power Module or gate drive. Minimized propagation delay difference between devices make these optocou- plers excellent solutions for improving inverter efficiency through reduced switching dead time.

3.

- (1)IPM Interface Isolation
- (2)Isolated IGBT/MOSFET Gate Drive
- (3)AC and Brushless DC Motor Drives
- (4)Industrial Inverters
- (5)General Digital Isolation

4.

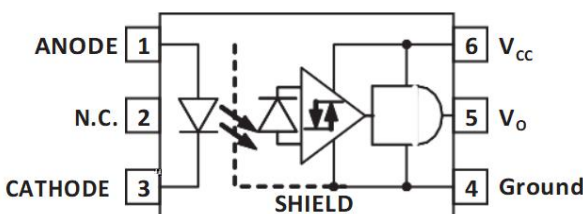

Truth Table	
0	0
0	1
1	0
1	1

Note: A 0.1 μF bypass capacitor must be connected between pins 4 and 6



5.

Input	Average Forward Input Current	I_F	50	mA
	Peak transient input forward current	I_{FPT}	1	A
	Reverse Input Voltage	V_R	5	V
Output	Average Output Current	I_O	25	mA
	Supply Voltage	V_{CC}	25	V
	Output Voltage	V_O	25	V
	Output Collector Power Dissipation	P_O	210	mW
Insulation Voltage		V_{iso}	5000	Vrms
Working Temperature		T_{opr}	-40 + 100	°C
Storage Temperature		T_{stg}	-55 + 125	
*2 Soldering Temperature		T_{sol}	260	

*1. Room temperature = 25 °C. Exceeding the maximum absolute rating can permanently damage the device. Working long hours at the maximum absolute rating can affect reliability.

*2. soldering time is 10 seconds.

6.

Power Supply Voltage	V_{CC}	4.5	20	V
Forward Input Current (ON)	$I_{F(ON)}$	6	10	mA
Forward Input Voltage (OFF)	$V_{F(OFF)}$	-	0.8	V
Operating Temperature	T_A	-40	100	°C



7.

Logic Low Output Voltage		—	0.08			$I_{OL} = 6.4 \text{ mA}$
Logic High Output Voltage				—		$I_{OH} = -2.6 \text{ mA}$
						$I_{OH} = -0.4 \text{ mA}$
						$I_{OH} = -1.6 \text{ mA}$
Output Leakage Current ($V_O = V_{CC} + 0.5V$)		—	—			$V_{CC} = 5 \text{ V}, I_F = 10 \text{ mA}$
		—	—			$V_{CC} = 20 \text{ V}, I_F = 10 \text{ mA}$
High Level Supply Current	I_{CCH}	—	0.9	2.5		$V_{CC} = 5.5 \text{ V}, I_F = 10 \text{ mA}, I_O = \text{Open}$
		—	1.1	2.5		$V_{CC} = 20 \text{ V}, I_F = 10 \text{ mA}, I_O = \text{Open}$
Low Level Supply Current	I_{CCL}	—	0.9	3.0		$V_{CC} = 5.5 \text{ V}, V_F = 0 \text{ V}, I_O = \text{Open}$
		—	1.2	3.0		$V_{CC} = 20 \text{ V}, V_F = 0 \text{ V}, I_O = \text{Open}$
Threshold Input Current Low to High	I_{FLH}	—	2.3	5.5		$C_g = 25 \text{ nF}, V_O > 5 \text{ V}$
Logic Low Short Circuit Output Current		25	185	—		$V_O = V_{CC} = 5.5 \text{ V}, V_F = 0V$
		50	175	—		$V_O = V_{CC} = 20 \text{ V}, V_F = 0V$
Logic High Short Circuit Output Current		—	-162	-25		$V_{CC} = 5.5 \text{ V}, I_F = 6 \text{ mA}, V_O = \text{GND}$
		—	-185	-50		$V_{CC} = 20 \text{ V}, I_F = 6 \text{ mA}, V_O = \text{GND}$
Input Forward Voltage	V_F	1.2	1.55	1.95		$I_F = 10 \text{ mA}$
Temperature Coefficient of Forward Voltage	$\Delta V_F / \Delta T$	—	-1.7	—		$I_F = 10 \text{ mA}$
Input Reverse Breakdown Voltage	B_{VR}	5	—	—		$I_R = 100 \mu\text{A}$
Input Capacitance	C_{IN}	—	70	—		$f = 1 \text{ MHz}, V_F = 0V$

8.

Propagation Delay Time to High Output Level	t_{PLH}	—	155	350	ns	With Peaking Capacitor
Propagation Delay Time to Low Output Level	t_{PHL}	—	145	350	ns	With Peaking Capacitor
Pulse Width Distortion	$ t_{PHL} - t_{PLH} = P_{WD}$	—	6.2	250	ns	
Propagation Delay Difference Between Any Two Parts	P_{DD}	-100	—	250	ns	
Rise Time	t_r	—	18	—	ns	
Fall Time	t_f	—	15	—	ns	
Output High Level Common Mode Transient Immunity	$ CM_H $	20	—	—	kV/ μs	$ V_{CM} = 1000 \text{ V}, I_F = 6.0 \text{ mA}, V_{CC} = 5 \text{ V}, T_A = 25^\circ\text{C}$
Output Low Level Common Mode Transient Immunity	$ CM_L $	20	—	—		$ V_{CM} = 1000 \text{ V}, V_F = 0 \text{ V}, V_{CC} = 5 \text{ V}, T_A = 25^\circ\text{C}$



9.

480= Part Number .

U = Lead form option ,W or W1 .

Y = Tape and reel option (TA,TA1 or none) .

Z = ‘V’ code for VDE safety (This options is not necessary).

* VDE Code can be selected.

S(TA)	Surface mount lead form (low profile) + TA tape & reel option	1000 units per reel
S(TA1)	Surface mount lead form (low profile) + TA1 tape & reel option	1000 units per reel

10.

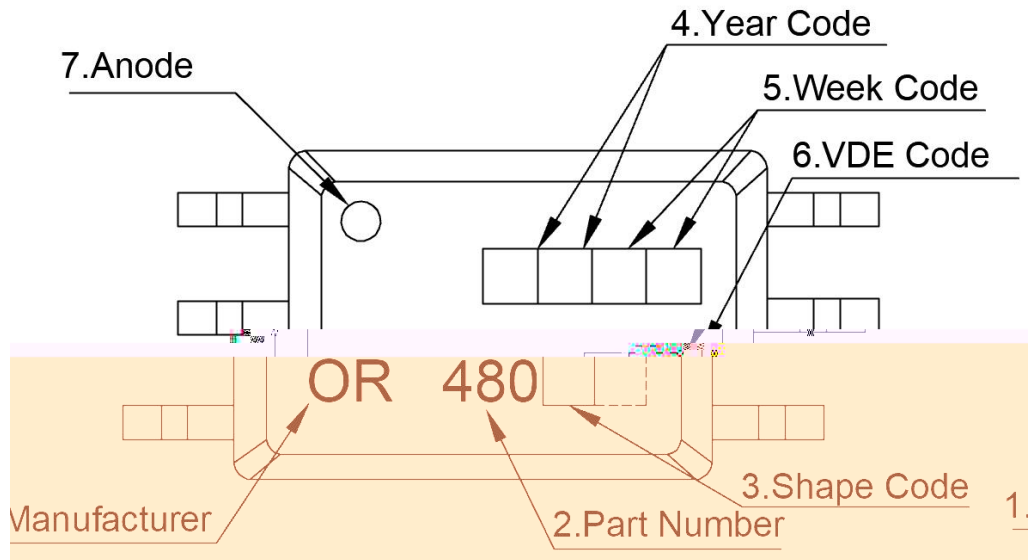

1. Manufacturer : ORIENT.
2. Part Number : 480.
3. Shape Code : Lead form option ,W or W1 .
4. Year Code '21' means '2021' and so on.
5. Week Code 01 means the first week, 02 means the second week and so on.
6. VDE Code . (Optional)
7. Anode.

* VDE Mark can be selected.

11.

(1).OR-480W

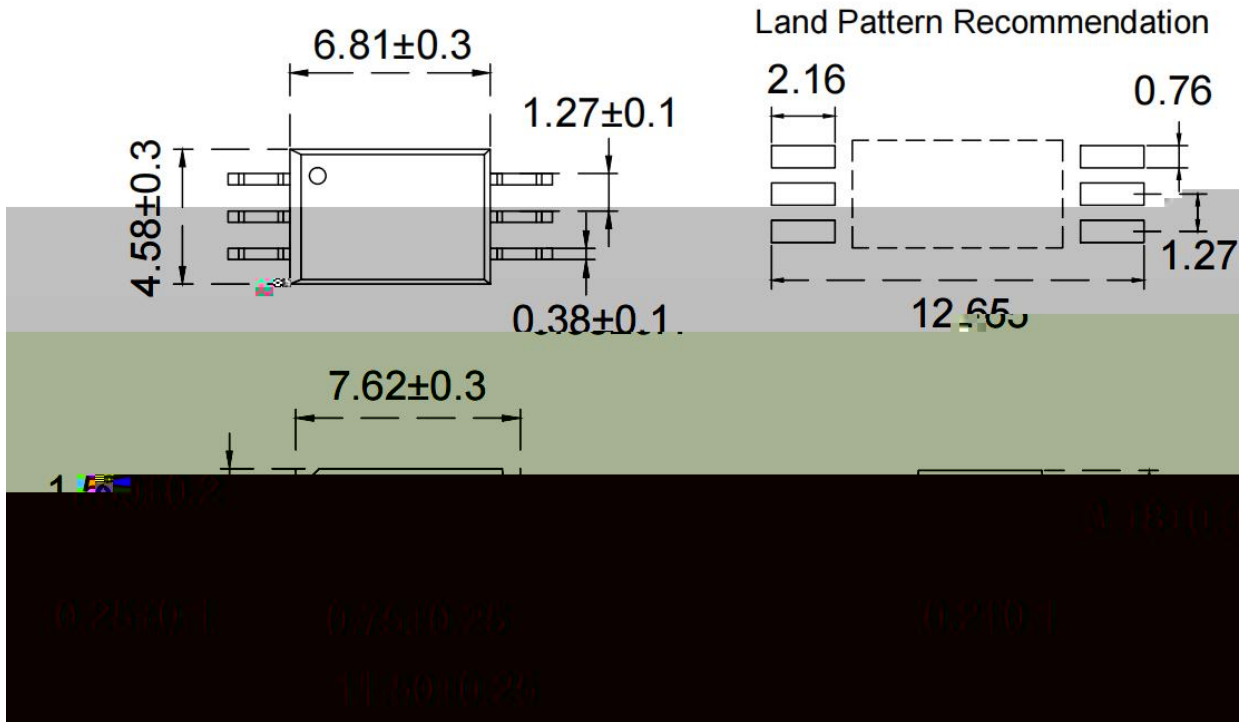

(2).OR-480W1

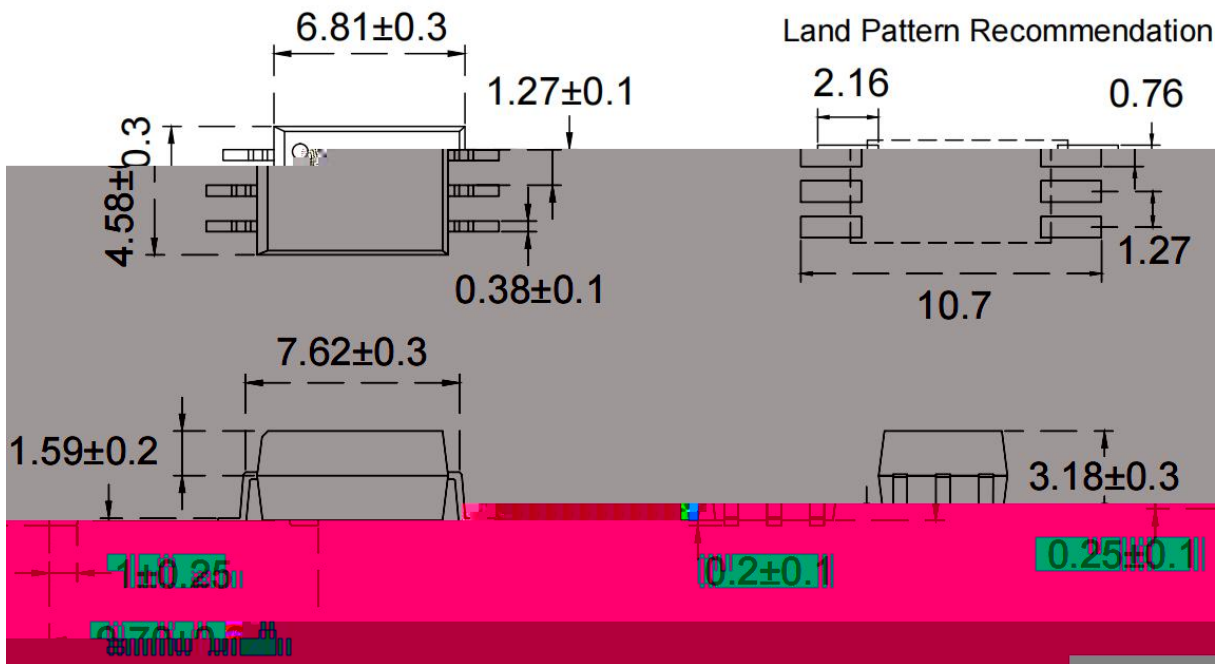



12.

(1)OR-480W-TA

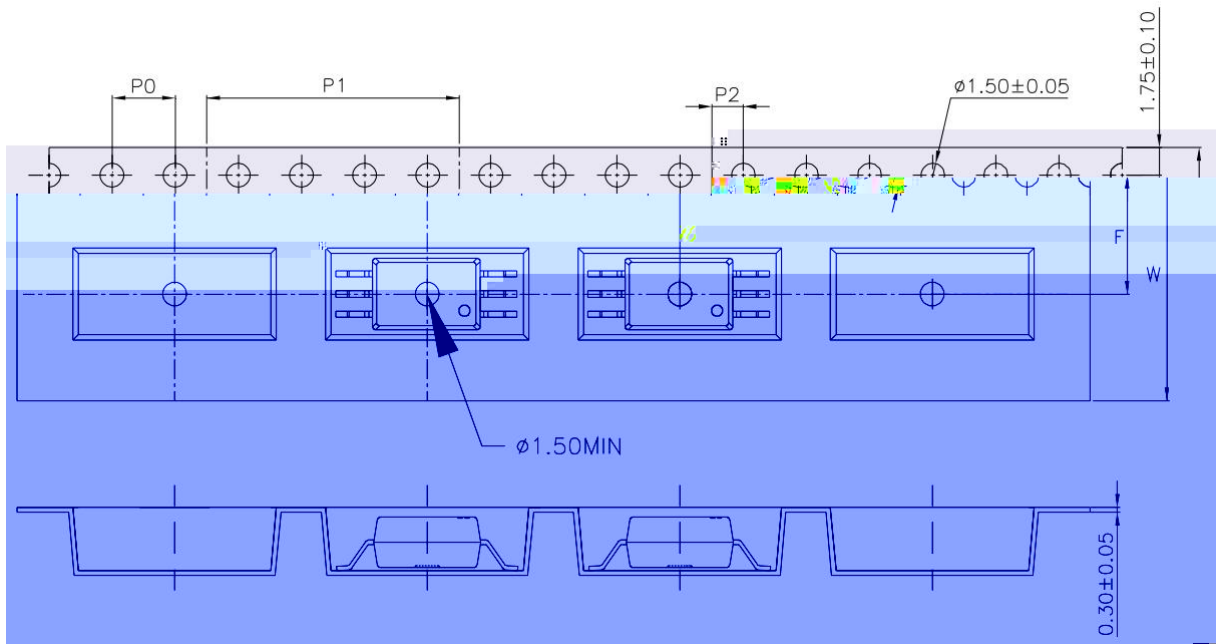

(2)OR-480W-TA1

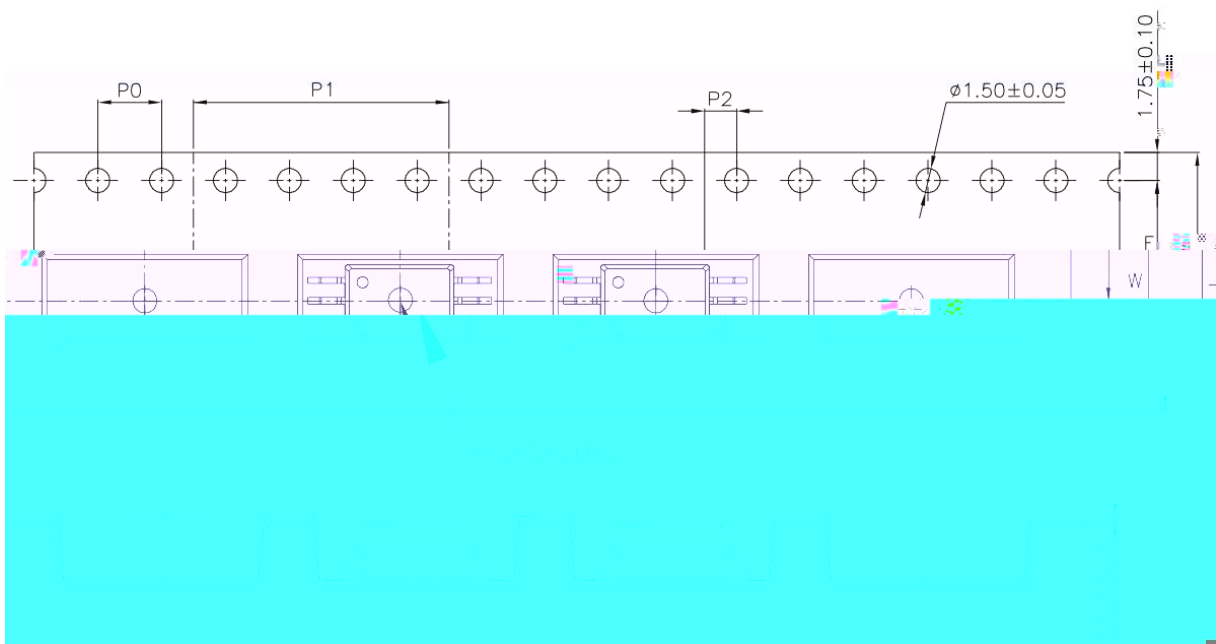

(1)OR-480W1-TA

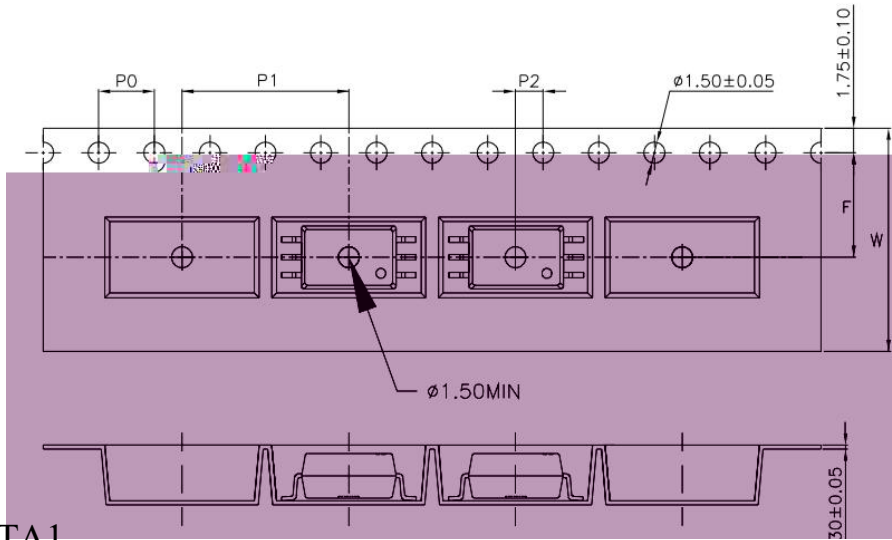

(2)OR-480W1-TA1

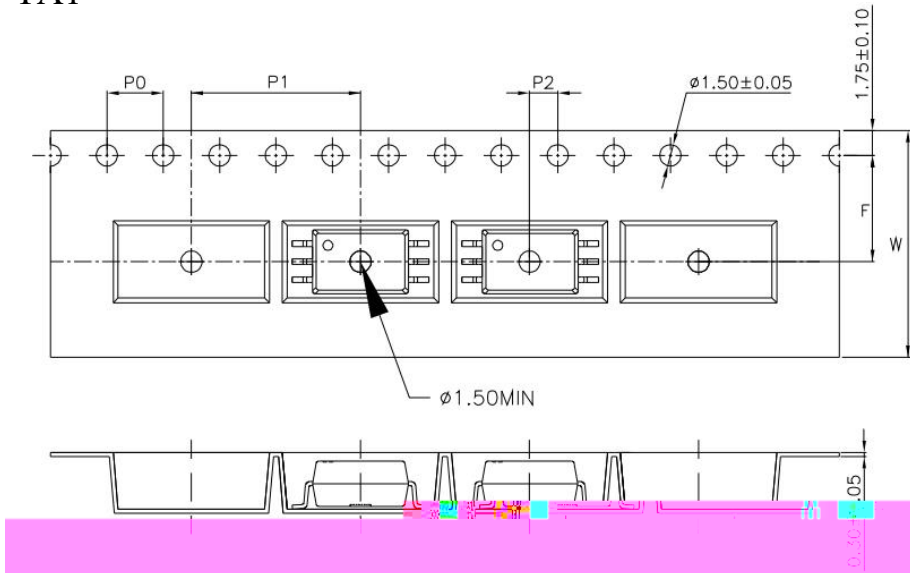

Type	symbol		
bandwidth	W	16 ± 0.3 (0.63)	16 ± 0.3 (0.63)
pitch	P0	4 ± 0.1 (0.16)	4 ± 0.1 (0.16)
pitch	F	7.5 ± 0.1 (0.3)	7.5 ± 0.1 (0.3)
	P2	2 ± 0.1 (0.079)	2 ± 0.1 (0.079)
interval	P1	16 ± 0.1 (0.63)	12 ± 0.1 (0.47)

Encapsulation type	TA/TA1
amount pcs	1000



13.

Packing type	Reel type
Tape Width	16mm
Qty per Reel	1,000pcs
Small box (inner) Dimension	345*345*58.5mm
Large box (Outer) Dimension	620x360x360mm
Max qty per small box	2,000pcs
Max qty per large box	20,000pcs

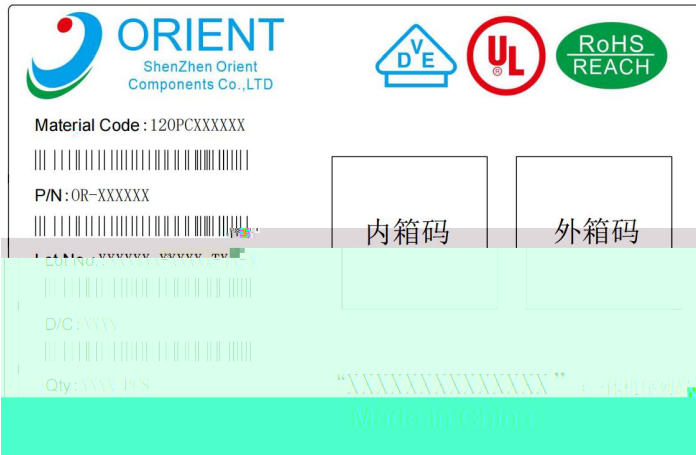

1. Material Code :Product ID.
2. P/N :Contents with "Order Information" in the specification.
3. Lot No. :Product data.
4. D/C :Product weeks.
5. Quantity :Packaging quantity.



14.

(1).IR Reflow soldering (JEDEC-STD-020C compliant)

One time soldering reflow is recommended within the condition of temperature and time profile shown below. Do not solder more than three times.

Preheat

- Temperature Min (T Smin)
- Temperature Max (T Smax)

One time soldering is recommended within the condition of temperature.

Temperature	260+0/-5°C
Time	10 sec
Preheat temperature	5 to 140°C
Preheat time	30 to 80 sec

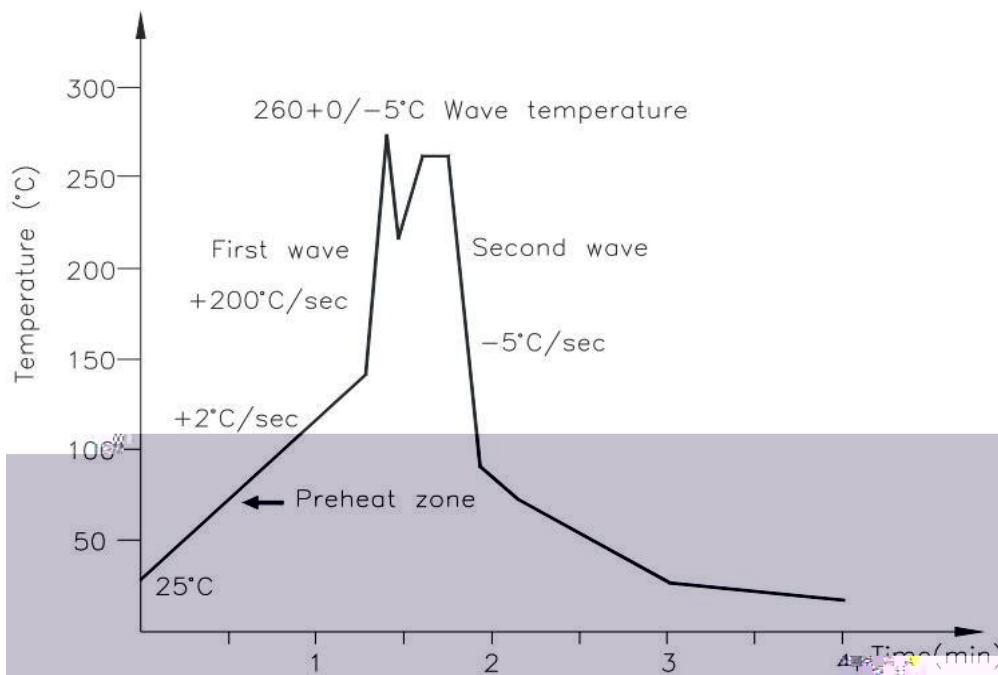

Allow single lead soldering in every single process. One time soldering is recommended.

--	--

15.

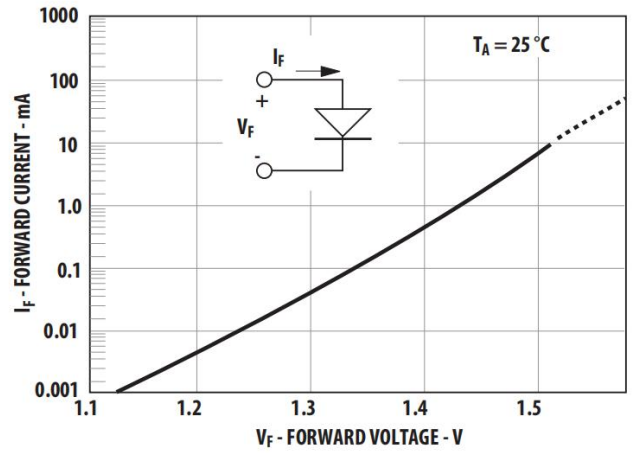
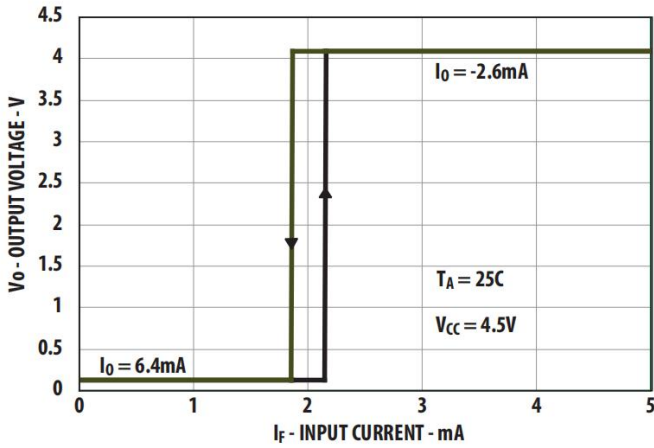
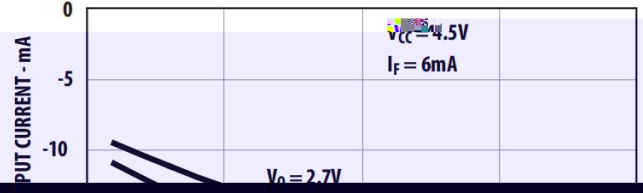
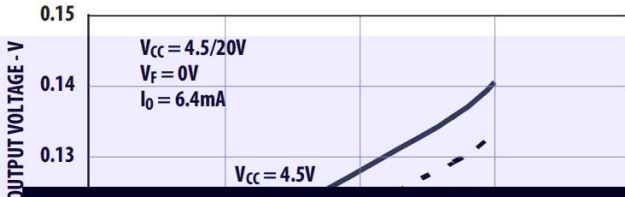

Figure 3. Typical Output Voltage vs. Forward Input Current

Figure 4. Typical Input Diode Forward Characteristic

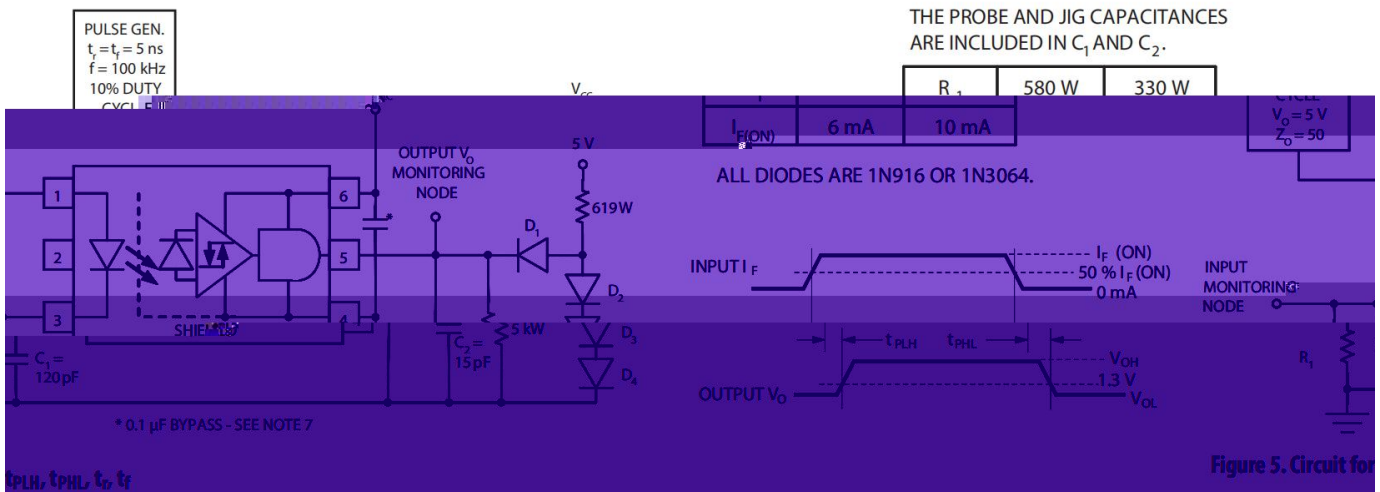

Figure 5. Circuit for

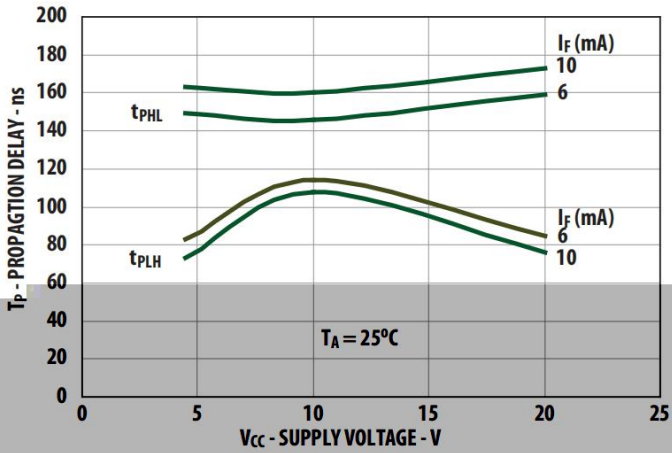
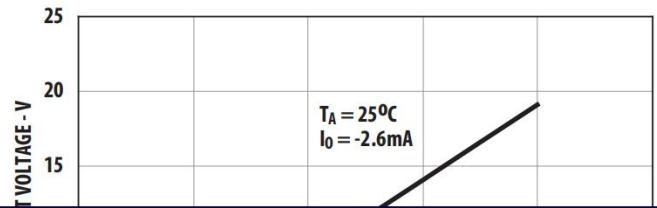
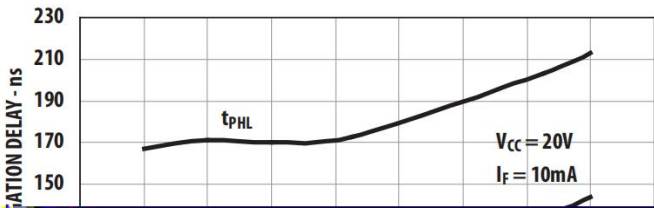
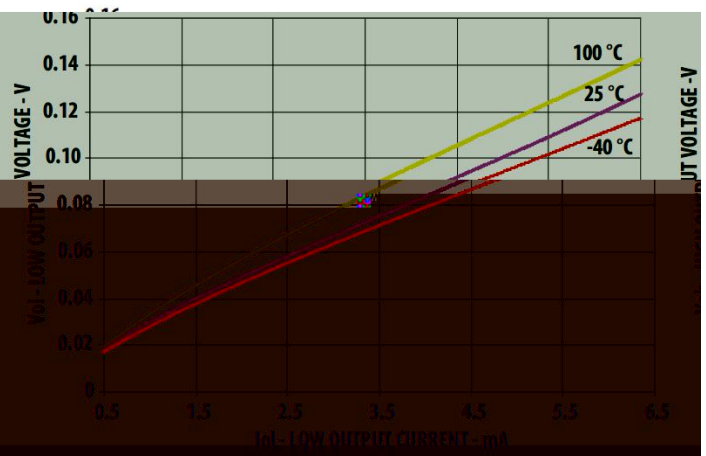
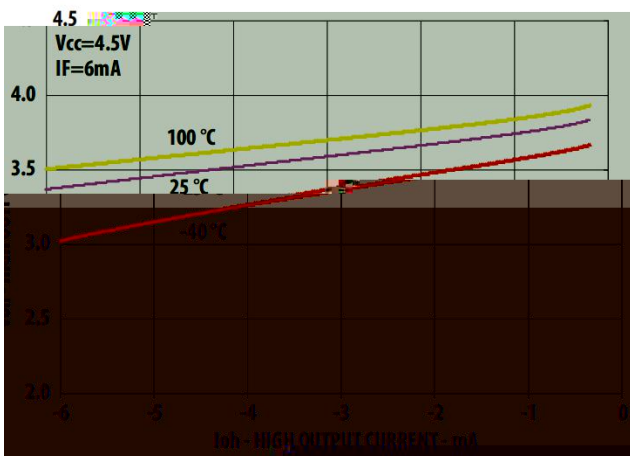

Figure 8. Typical Propagation Delay vs. Supply Voltage



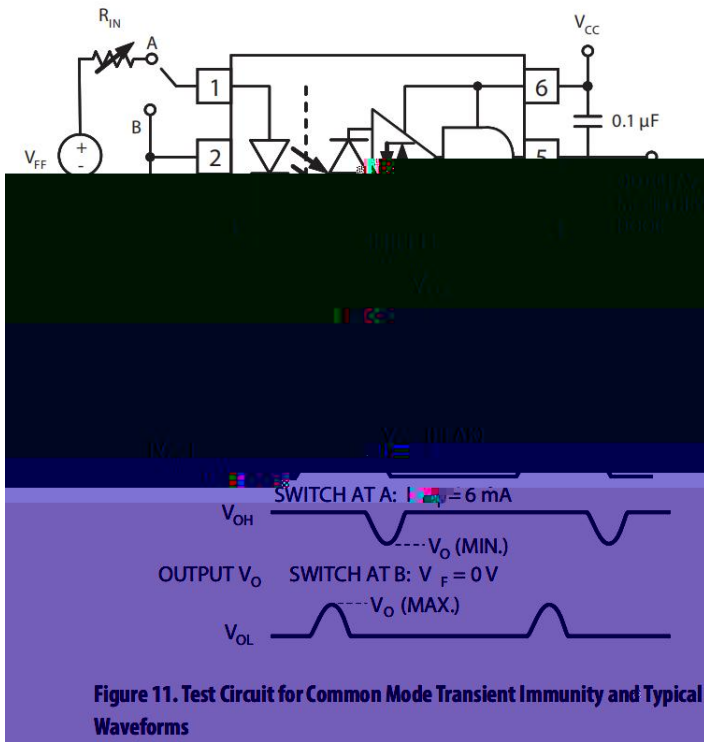

Figure 11. Test Circuit for Common Mode Transient Immunity and Typical Waveforms