



ORIENT

Photo coupler

Product Data Sheet

Name: OR-M6XX

Customer: _____

Date: _____

一级代理商：

深圳市弗瑞鑫电子有限公司

地址：深圳市宝安区西乡大道302号金源商务大厦B座三楼

frxelec

1. Features

- (1) Compliance Halogens Free (Br < 900ppm, Cl < 900ppm, Br+Cl <1500ppm)
- (2) 3.3V / 5V supply voltage
- (3) low power consumption
- (4) high speed: 10MBd(typical)
- (5) VCM=1000V, and the lowest common mode inhibition (CMR) is 10 kV/ s
- (6) when - 40 + 125 temperature of ac and dc performance
- (7) Safety approval
 - UL approved(No.E323844)
 - VDE approved(No.40029733)
 - CQC approved (No.CQC19001231256)
- (8) In compliance with RoHS, REACH standards
- (9) MSL Class



2. Instructions

OR-M6XX is made up of an efficient AlGaAs light-emitting diode and high-speed optical detector. This design provides good ac and dc isolation between the input and output ends of the photoelectric coupler. The output characteristic of the photodetector is a collector open circuit schottky clamp transistor. The photoelectric coupler operating temperature range: - 40 + 125 .

3. Application Range

- (1)Ground loop elimination
- (2)LSTTL to TTL, LSTTL or 5 volt CMOS
- (3)Line receiver, data transmission
- (4)Data multiplexing
- (5)Switching power supplies
- (6)Pulse transformer replacement
- (7)Computer peripheral interface

4. Functional Diagram

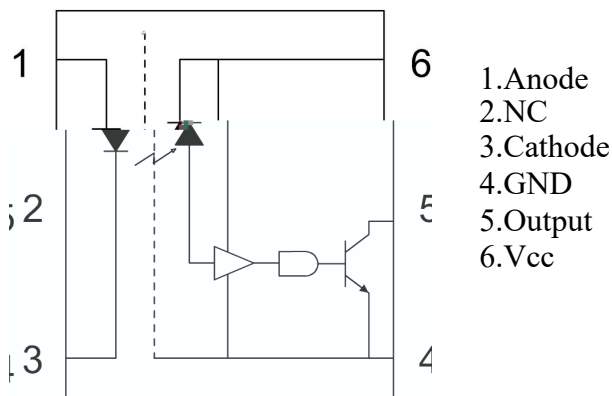

- 1.Anode
- 2.NC
- 3.Cathode
- 4.GND
- 5.Output
- 6.Vcc

Truth table

Input	LED	Output
	ON	L
	OFF	H

0.1 capacitor F bypass capacitance needs to be connected between A Pin4 and Pin6

5. Absolute Maximum Ratings (Ta=25°C)*1

Parameter		Symbol	Rated Value	Unit
Input	Average Forward Input Current	I _F	50	mA
	Reverse Input Voltage	V _R	5	V
	Power Dissipation	P _I	40	mW
Output	Output Collector Current	I _O	50	mA
	Output Collector Voltage	V _O	7	V
	Output Collector Power Dissipation	P _O	85	mW
Supply Voltage		V _{CC}	7	V
Insulation Voltage		V _{iso}	3750	V _{rms}
Working Temperature		T _{opr}	-40 + 125	
Storage Temperature		T _{stg}	-55 + 150	
*2	Soldering Temperature	T _{sol}	260	

*1. Room temperature = 25 . Exceeding the maximum absolute rating can permanently damage the device. Working long hours at the maximum absolute rating can affect reliability.

*2. soldering time is 10 seconds.

6. Recommended Operating Conditions

Parameter	Symbol	Min	Max	Unit
Operating Temperature	T _A	-40	125	
Supply Voltage	V _{CC}	2.7	3.6	V
		4.5	5.5	
Low Level Input Current	I _{FL}	0	250	A
High Level Input Current	I _{FH}	5	15	mA
Output Pull-up Resistor	R _L	330	4000	
Fan Out (at R _L =1k per channel)	N		5	TTL Loads

7. Opto-Electronic Characteristics

	Parameter	Symbol	Min	Typ	Max	Unit	Condition
Input	Forward Voltage	V_F		1.38	1.8	V	$I_F = 10\text{mA}$ $T_A = 25\text{ }^\circ\text{C}$
	Temperature Coefficient OF Forward Voltage	V_F / T		-1.6		mV/	$I_F = 10\text{mA}$
	Reverse Voltage	BV_R	5			V	$I_R = 10\text{ }^\circ\text{A}$
	Input Threshold Current	I_{TH}		1.5	5	mA	$V_E = 2\text{V}, V_{CC} = 3.3\text{V}$ $V_O = 0.6\text{V}$ $I_{OL} (\text{sinking}) = 13\text{mA}$
	Input Capacitance	C_{IN}		34		pF	$f = 1\text{MH}$, $V_F = 0\text{V}$
Detector	High Level Supply Current	I_{CCH}		3.8	7	mA	$V_{CC} = 3.3\text{V}, I_F = 0\text{mA}$
	Low Level Supply Current	I_{CCL}		5.8	10	mA	$V_{CC} = 3.3\text{V}, I_F = 10\text{mA}$
	High Level Output Current	I_{OH}		5	100	A	$V_{CC} = 3.3\text{V}$ $V_O = 3.2\text{V}, I_F = 250\text{ }^\circ\text{A}$
	Low Level Output Voltage	V_{OL}		0.3	0.6	V	$V_{CC} = 3.3\text{V}$ $I_F = 5\text{mA}$, $I_{OL} (\text{sinking}) = 13\text{mA}$

Recommended temperature range ($T_A = -40 \sim +125$, $2.7\text{V} \leq V_{CC} \leq 3.6\text{V}$), $I_F = 7.5\text{mA}$ Unless otherwise stated.
 Typical values $T_A = 25$, $V_{CC} = 3.3\text{V}$.

Parameter		Symbol	Min	Typ	Max	Unit	Condition
Input	Forward Voltage	V_F		1.38	1.8	V	$I_F=10\text{mA}$ $T_A=25\text{ }^\circ\text{C}$
	Temperature Coefficient OF Forward Voltage	V_F/ T		-1.6		mV/	$I_F=10\text{mA}$
	Reverse Voltage	BV_R	5			V	$I_R=10\text{ }^\circ\text{A}$
	Input Threshold Current	I_{TH}		1.5	5	mA	$V_{CC}=5.5\text{V}, V_O=0.6\text{V}$ $I_{OL}>13\text{mA}$
	Input Capacitance	C_{IN}		34		pF	$f=1\text{MH}$, $V_F=0\text{V}$
Detector	High Level Supply Current	I_{CCH}		6	10	mA	$V_{CC}=5.5\text{V}, I_F=0\text{mA}$
	Low Level Supply Current	I_{CCL}		8	13	mA	$V_{CC}=5.5\text{V}, I_F=10\text{mA}$
	High Level Output Current	I_{OH}		3	100	A	$V_{CC}=5.5\text{V}$ $V_O=5.5\text{V}, I_F=250\text{ }^\circ\text{A}$
	Low Level Output Voltage	V_{OL}		0.4	0.6	V	$V_{CC}=5.5\text{V}$ $I_F=5\text{mA}$, $I_{OL}(\text{sinking})=13\text{mA}$

Recommended temperature range($T_A = -40$ ~ $+125$, $4.5\text{V} \leq V_{CC} \leq 5.5\text{V}$), $I_F = 7.5\text{mA}$ Unless otherwise stated. Typical values $T_A = 25$, $V_{CC} = 5.0\text{V}$.



8. Switching Characteristics

Parameter	Symbol	Min	Typ	Max	Unit	Condition
Propagation delay time to output High level	t_{PLH}		60	90	ns	
Propagation delay time to output Low level	t_{PHL}		25	75	ns	

$R_L=350$
 $C_L=15pF$

9. Order Information

Part Number

OR-M6XX-W-Y-Z

Note

XX = Type code. (00 , 01 , 11)

W = Tape and reel option. (TP or TP1).

Y = V code for VDE safety (This options is not necessary).

Z = G code for Halogen free.

* VDE Code can be selected.

Option	Description	Packing quantity
TP	Surface mount lead form (low profile) + TP tape & reel option	3000 units per reel
TP1	Surface mount lead form (low profile) + TP1 tape & reel option	3000 units per reel

10. Naming Rule

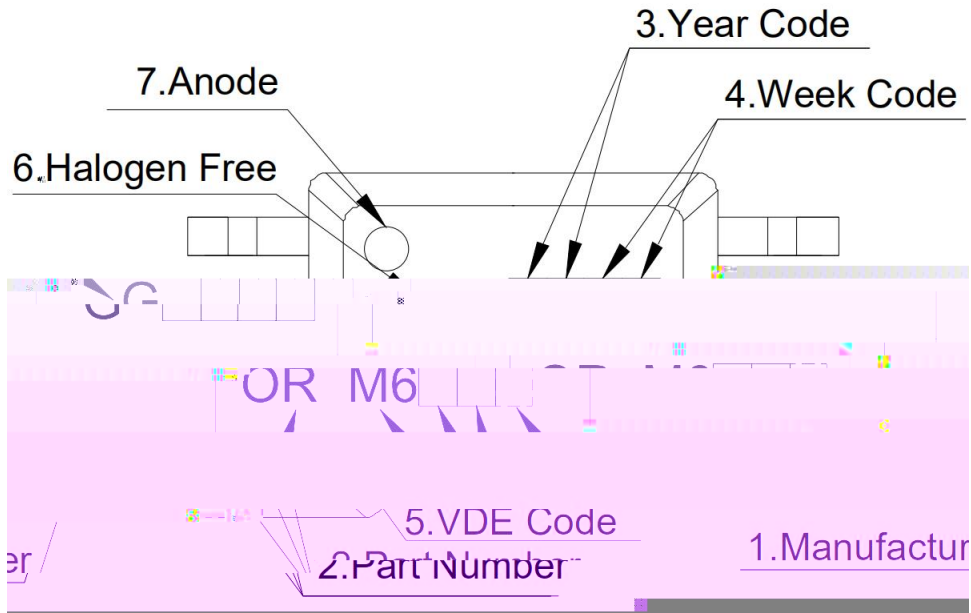

1. Manufacturer : ORIENT.

2. Part Number : M600, M601 or M611.

3. Year Code : '21' means '2021' and so on.

4. Week Code : 01 means the first week, 02 means the second week and so on.

5. VDE Code . (Optional)

6. HF Code G : Halogen Free.

7. Anode.

* VDE Code can be selected.

11. Outer Dimension

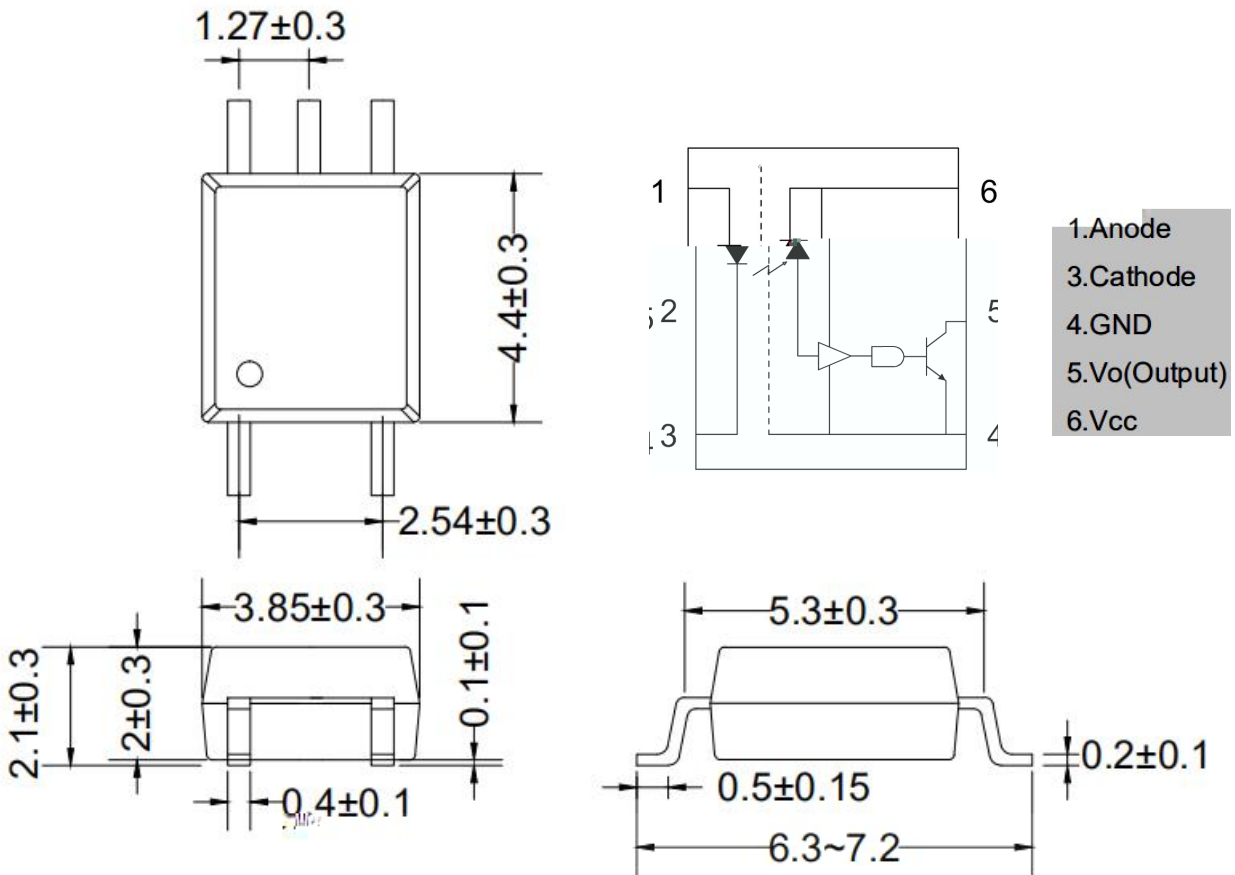

12. Recommended Foot Print Patterns (Mount Pad)

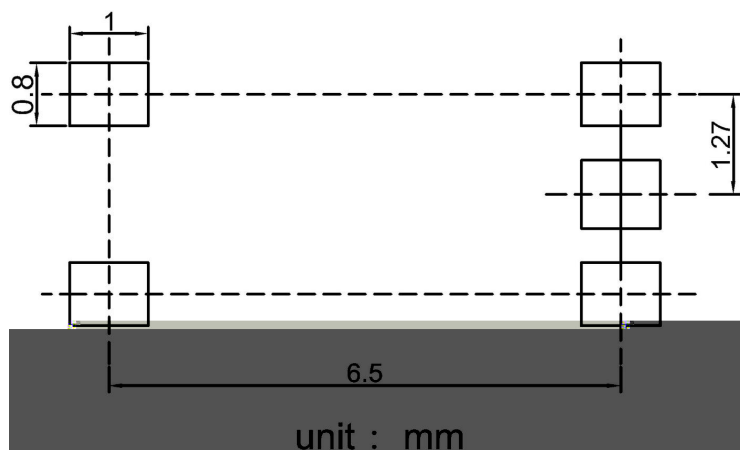

14. Package Dimension

(1) package dimension

Packing Information	
Packing type	Reel type
Tape Width	12mm
Qty per Reel	3,000pcs
Small box (inner) Dimension	345*345*45mm
Large box (Outer) Dimension	480x360x360mm
Max qty per small box	6,000pcs
Max qty per large box	60,000pcs

(2) Packing Label Sample



Note:

1. Material Code :Product ID.
2. P/N :Contents with "Order Information" in the specification.
3. Lot No. :Product data.
4. D/C :Product weeks.
5. Quantity :Packaging quantity.

15. Reliability Test

NO.	ITEMS	Reliability Testing				
		QTY. (Pcs)	Condition	Process	Device	Standard
1	RSH 耐焊接热	22	260 5	5s/3 次	锡炉	JESD22-A106
2	HTSL 高温存储	77	125	168 hrs	高温烤箱 测试仪	JESD22-A103
				500 hrs		
				1000 hrs		
3	LTSL 低温存储	77	-40	168 hrs	低温箱 测试仪	JESD22-A119
				500 hrs		
				1000 hrs		
4	TC 温度循环	77	H:125 15min 5min L:-55 15min	300 cycle	冷热冲击机	JESD22-A104
5	TS 温度冲击	77	H:100 5min 15s L:-40 5min	300 cycle	冷热冲击机	JESD22-A106
6	HTOL 高温操作	77	100 C IF=10mA Vcc=5V	168 hrs	高温烤箱 测试仪、 老化电 路板	JESD22-A108
				500 hrs		
				1000 hrs		
7	ESD-HB M 人体模式	22	8KV 1Cycle	1 次	ESD 静电测试仪	JESD22-A114
8	SD 可焊性	22	Pb-free 245 5	5s/1 次	锡炉	JESD22-B102
9	HTHB 温湿寿命 试验	77	85 ,85%RH IF=10mA,Vcc=5V	168 hrs	恒温恒湿机, 测试仪	JESD22-A101
				500 hrs		
				1000 hrs		
10	Autoclave 压力锅	77	Ta=121 ,100%RH,2atm	96hrs	压力锅	JESD22-A102

16. Temperature Profile Of Soldering

1 IR Reflow soldering (JEDEC-STD-020C compliant)

Note: one solder backflow is recommended under the conditions described below in the temperature and time profile. Do not weld more than three times.

Profile item	Conditions
Preheat	
- Temperature Min (T Smin)	150 C
- Temperature Max (T Smax)	200 C
- Time (min to max) (ts)	90 30 sec
Soldering one	
- Temperature (TL)	217 C
- Time (t L)	60 sec
Peak Temperature	260 C
Peak Temperature time	20 sec
Ramp-up rate	3 C / sec max.
Ramp-down rate from peak temperature	3 6 C / sec
Reflow times	3

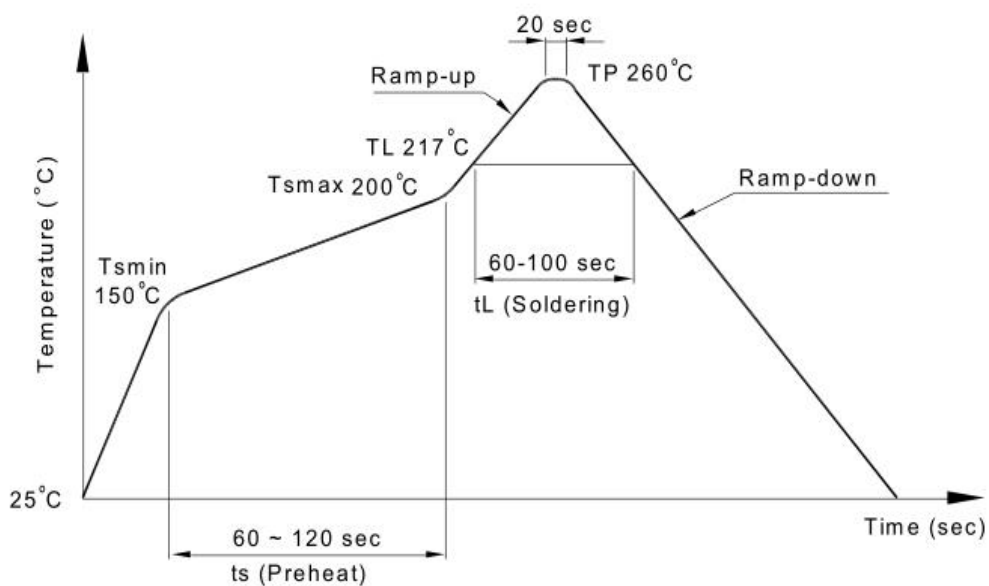

2 Wave soldering (JEDEC22A111 compliant)

One-time welding is recommended under the temperature condition.

Temperature	260+0/-5 C
Time	10 sec
Preheat temperature	5 to 140 C
Preheat time	30 to 80 sec

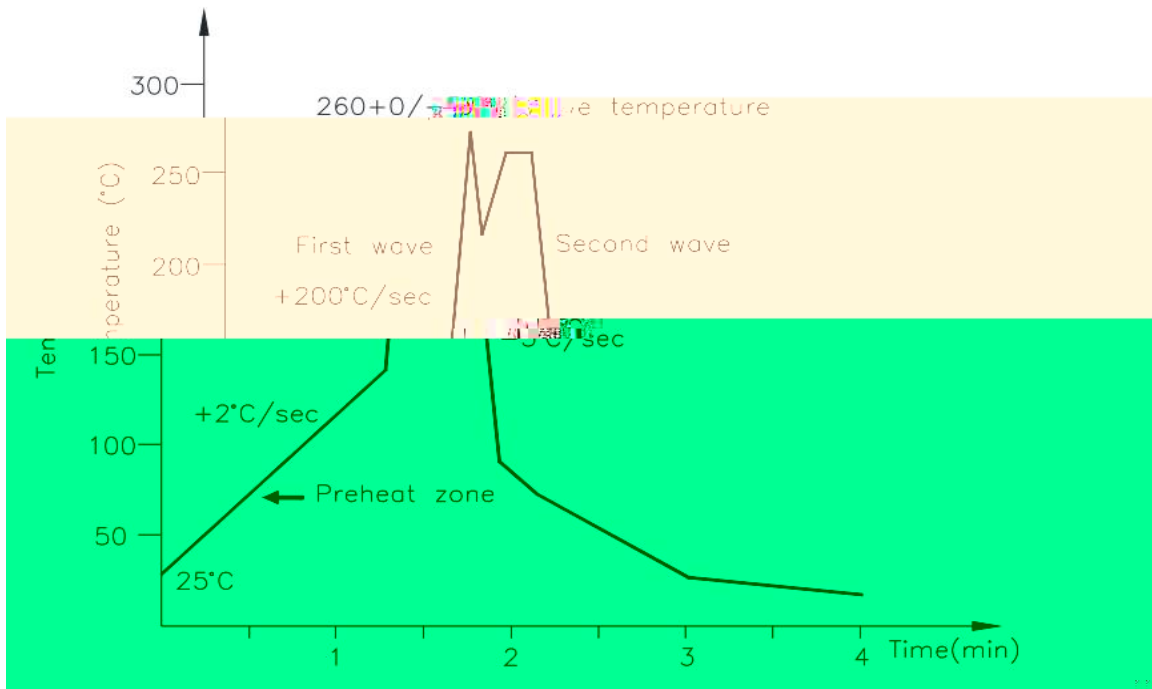

3 Hand soldering by soldering iron

Single lead welding is allowed in each process and one-time welding is recommended.

Temperature	380+0/-5 C
Time	3 sec max

17. Switching time test circuit

Figure 1 Test Circuit for T_{PHL} and T_{PLH}

Figure 2 Single Channel Test Circuit for Common Mode Tr

18. Characteristics Curve

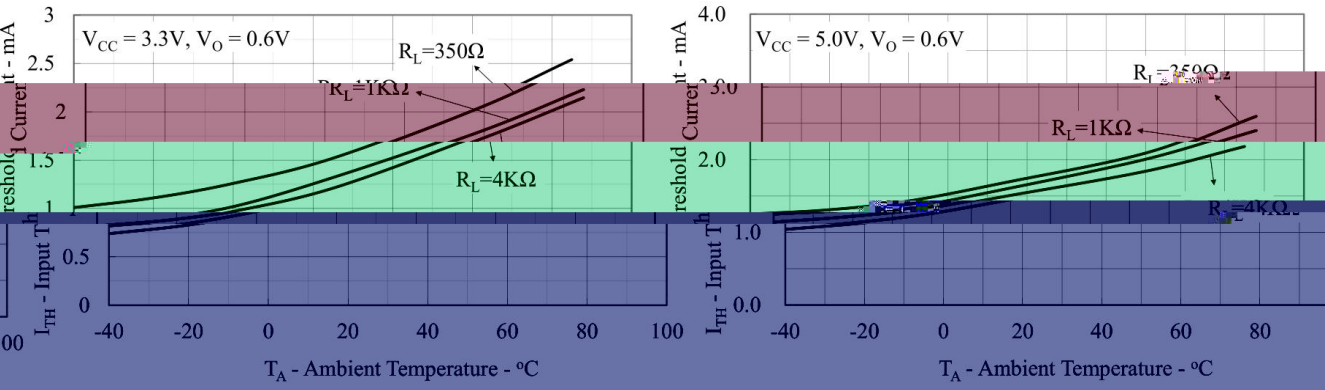
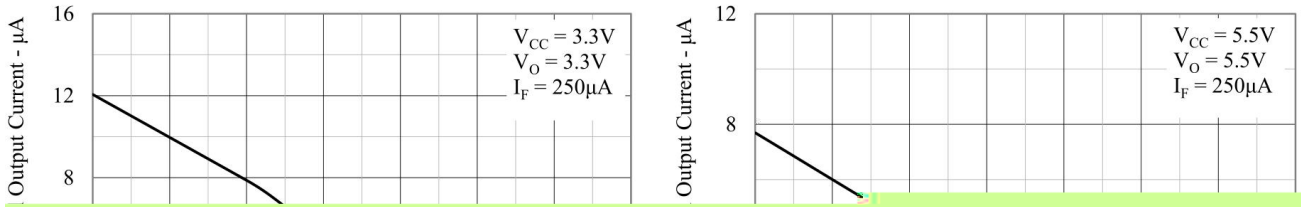

Figure 4: Typical Input Threshold Current vs. Ambient Temperature

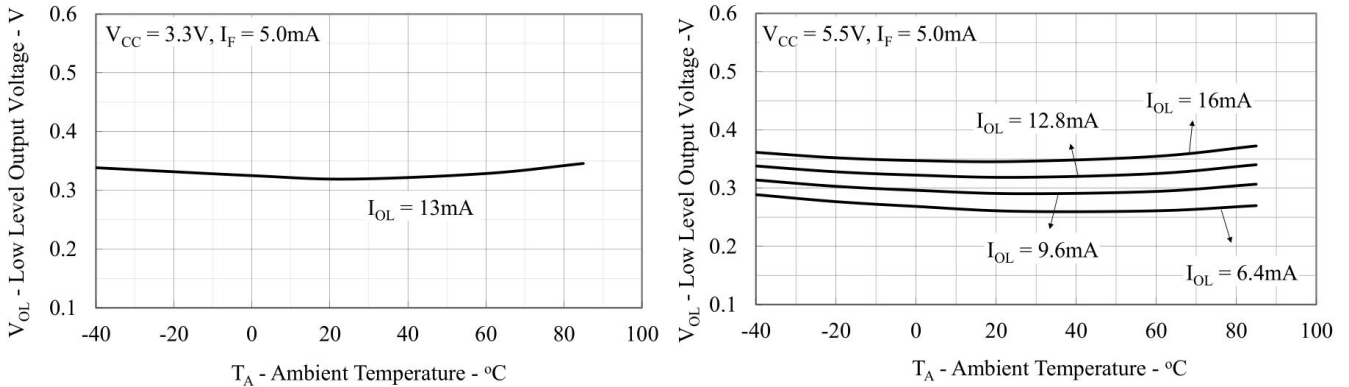

Figure 5: Typical Low Level Output Voltage vs. Ambient Temperature

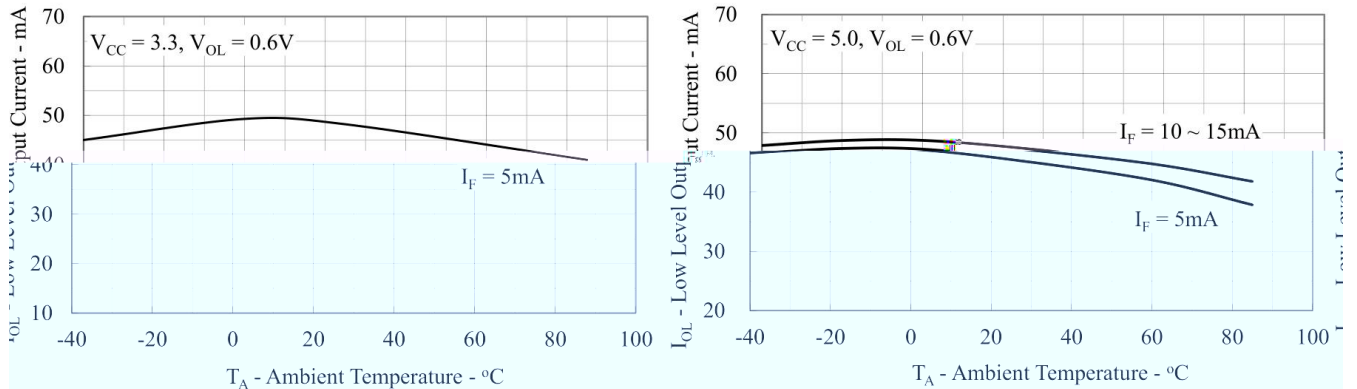

Figure 6: Typical Low Level Output Current vs. Ambient Temperature

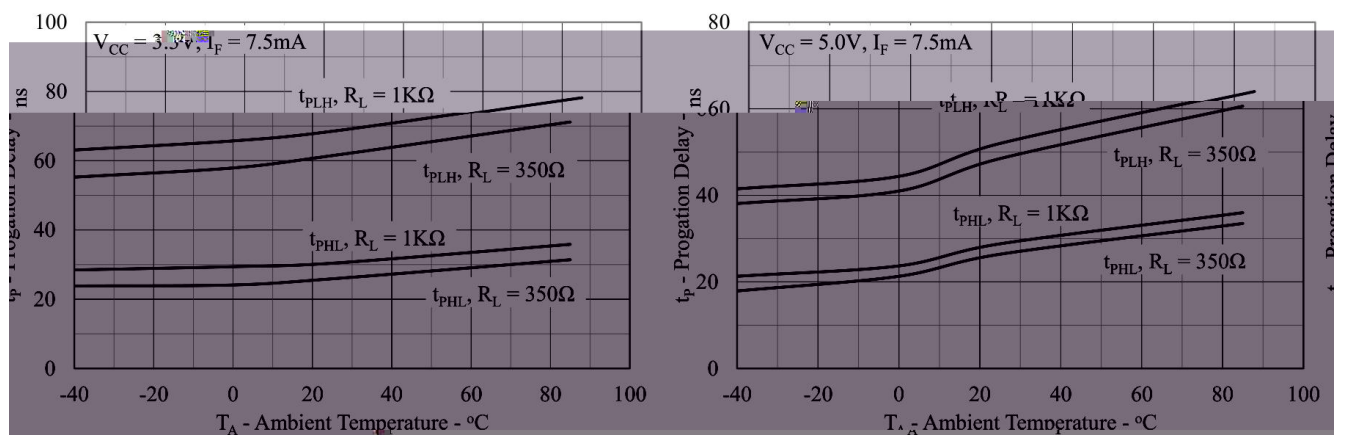
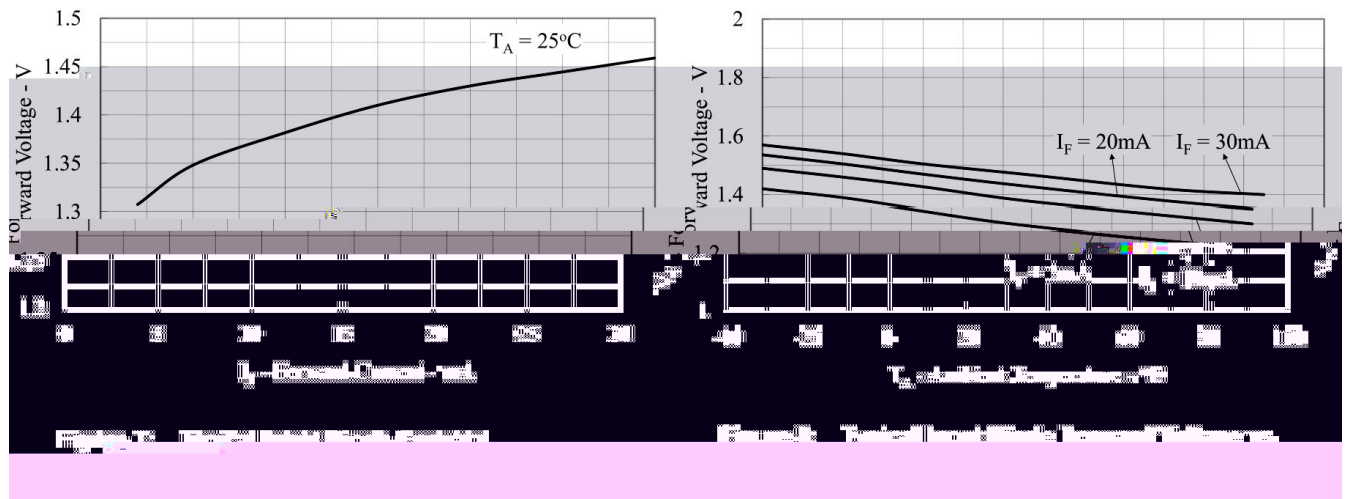

Figure 8: Typical Propagation Delay vs. Ambient Temperature

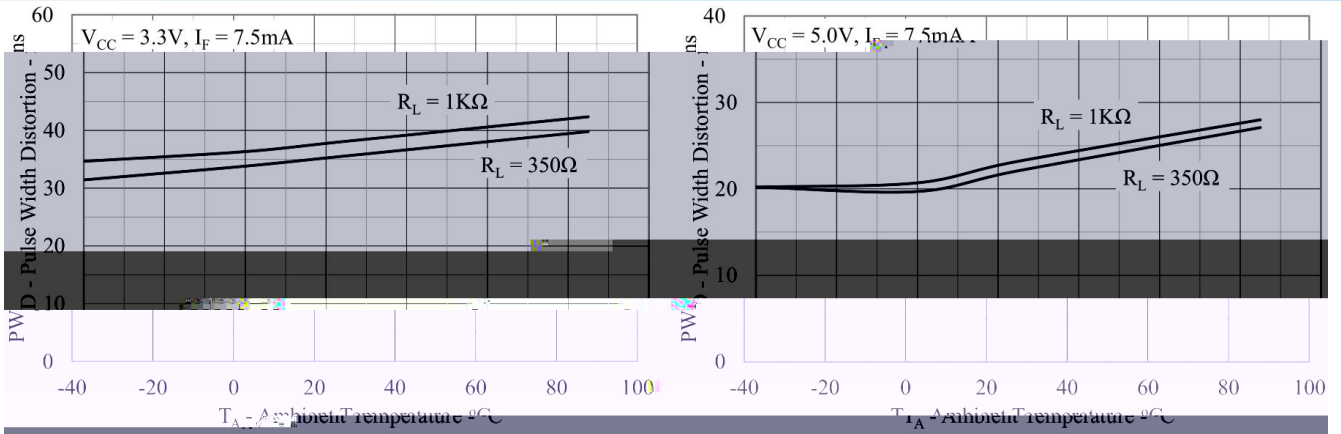

Figure 10: Typical Pulse Width Distortion vs. Ambient

