



# 深圳市弗瑞鑫电子有限公司

## 规格承认书

:   /    
 :            单  
 :            单

prepare	
check	
/	
approve	



**TRX电容一级代理商**  
**深圳市弗瑞鑫电子有限公司**

Add: 深圳市宝安区西乡大道302号金源商务大厦B座3楼  
 Tel: 0755-29563634  
 Fax: 0755-27447020

- 2

2 . .

/

/

/

/

	- 2 2 . .		
	/		/
	/		/

	- 2 2 . .		
	/		/
	/		/

1. /

$\overline{\text{①}}$   $\overline{\text{②}}$   $\overline{\text{③}}$   $\overline{\text{④}}$   $\overline{\text{⑤}}$   $\overline{\text{⑥}}$

①

	- 2 2 . .		
	/		/
	/		/

3. /



4. /

5. /





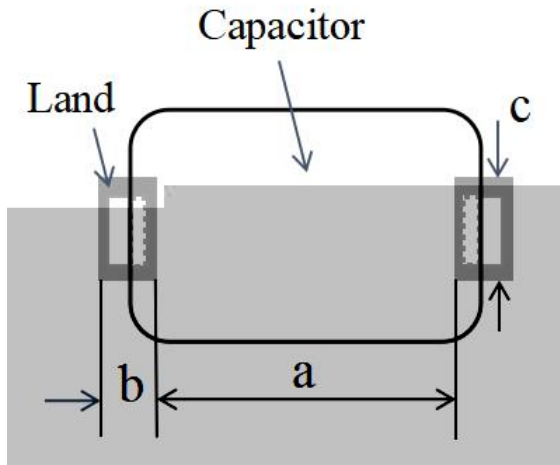

①		
②		
③		
④		
⑤		

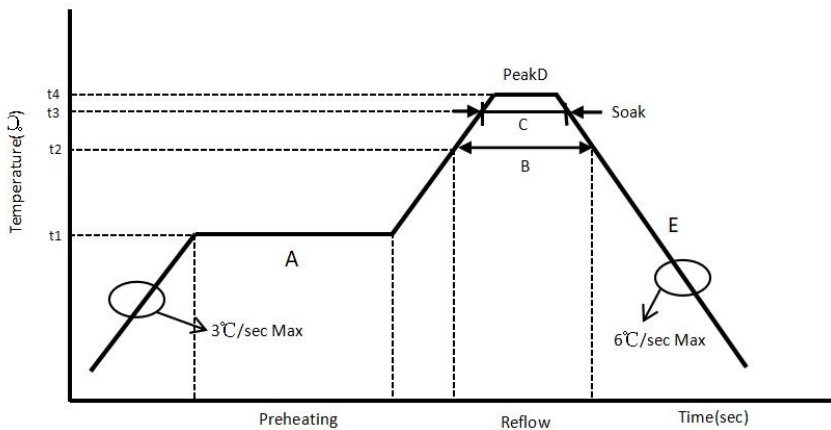

6. /  
/

°  
°C  
°  
°  
°



	- 2 2 . .		
	/		/
	/		/

/

°  
°C

°

°

°

/

7. /



	- 2 2 . .		
	/		/
	/		/





- 2  
2 ..

/

/

/

/

					±
		±			
		±			
		±			
		±			





			± ±
			± ± ±
			± ± ±
			± ± ±

8. /

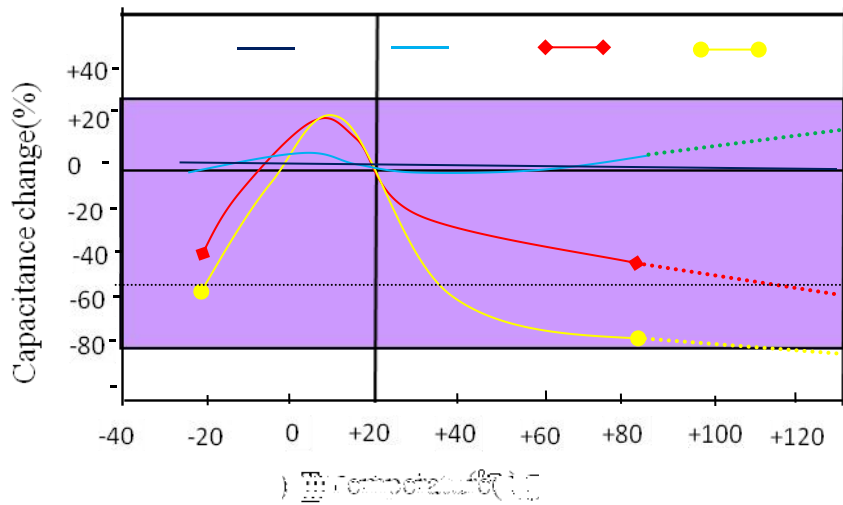



11. /  
/

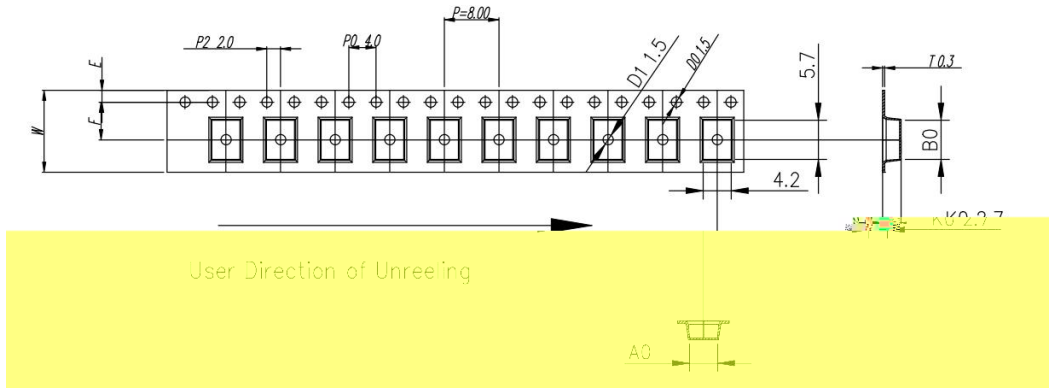

ITEM	W	A0	B0	K1	K0	P	F	E	D0	D1	P0	P2	T
DIM	12.0 ±0.30	4.2 ±0.10	5.70 ±0.10	--	2.70 ±0.10	8.00 ±0.10	5.50 ±0.10	1.75 ±0.10	∅1.5 ±0.05	∅1.5 ±0.10	4.0 ±0.10	2.0 ±0.10	0.30 ±0.05
ALTERNATE													

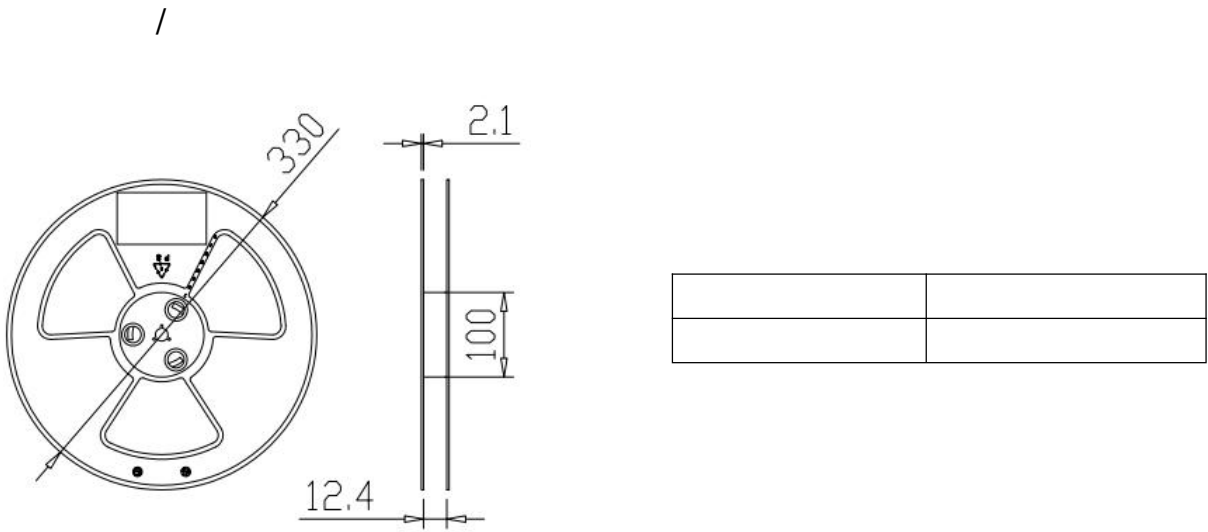

/

Item	Data	Remark
Cover tape adhesion	10 ~ 100g	Carrier tape and cover tape open angle 165 ~ 180° F=300±5mm/minute

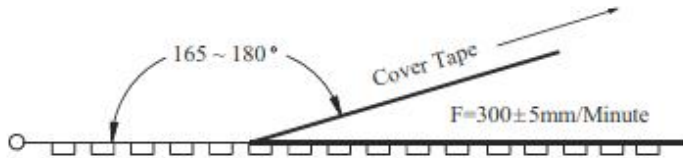



- 2  
2 . .

/		/	
/		/	

/ -

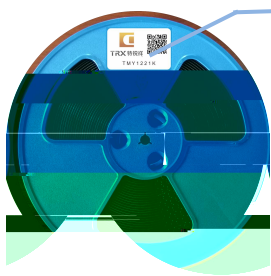

标签



料号

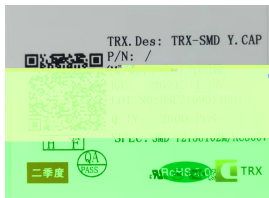

/ -

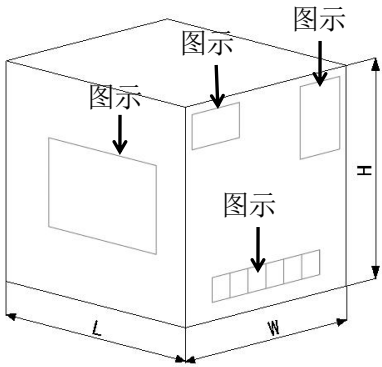

图示 /

图示 /

图示 /



/ :



/

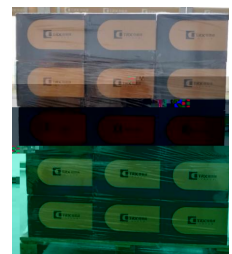

/



" "



	- 2 2 . .		
	/		/
	/		/

12. /

①

②