



深圳市弗瑞鑫电子有限公司

规格承认书

—
————
————

prepare	
check	
approve	



TRX电容一级代理商

深圳市弗瑞鑫电子有限公司

Add:深圳市宝安区西乡大道302号金源商务大厦B座3楼

Tel:0755-29563634

Fax:0755-27447020

- 2

2 . .

/	-3-082	/	2021-11-15
/	A1	/	P 3 18

 TRX 专注电容器廿年	- 2 2 . .			
	/	-3-082	/	2021-11-15
	/	A1	/	P 4 18

/CON EN

1.	P	N	-----	5
2.	P		-----	5-6
3.	D		-----	6
4.	C		-----	7
5.	P		-----	7-8
6.			-----	8-9
7.	P		-----	9-14
8.	C		-----	14
9.	C		-----	15
10.			-----	15
11.	P	P	-----	16-17
12.	A		-----	18

	- 2 2 . .			
	/	-3-082	/	2021-11-15
	/	A1	/	P 5 18

1. /

$\overline{\text{①}}$ $\overline{\text{②}}$ $\overline{\text{③}}$ $\overline{\text{④}}$ $\overline{\text{⑤}}$ $\overline{\text{⑥}}$

N . C

E

①

L

 TRX 专注电容器廿年	- 2 2 . .			
	/	-3-082	/	2021-11-15
	/	A1	/	P 6 18

3. /



		2020	M	1	01	1	01	16	16
		2021	N	2	02	2	02	17	17
2010	A	2022	P	3	03	3	03	18	18
2011	B	2023		4	04	4	04	19	19
2012	C	2024		5	05	5	05	20	20
2013	D	2025		6	06	6	06	21	21
2014	E	2026		7	07	7	07	22	22
2015	F	2027		8	08	8	08	23	23
2016	H	2028		9	09	9	09	24	24
2017	J	2029		10	10	10	10		

4. /

C		C	C
L/C L	L/C A 60384-14	E315719	AC300 (. . .)
C C	GB/ 6346.14-2015	C C20001280609	AC300 (. . .)
ENEC	EN 60384-14:2013/A1:2016	ENEC-03177	AC300 (. . .)
KC	K60384-14	H 03034-21003A	AC250 (. . .)

5. /

5.1 /P D

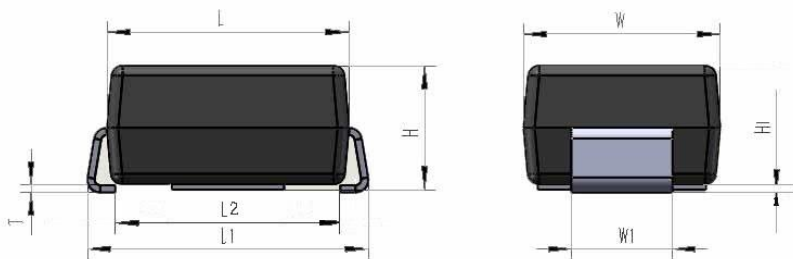

P		D		()	
L	4.3 0.1			3.5 0.3	
L1	5.0 0.1	L2		4.0 0.1	
H	2.2 0.1	1		1.8 0.05	
H1	0.1 0.05			0.13 0.02	

5.2 /P

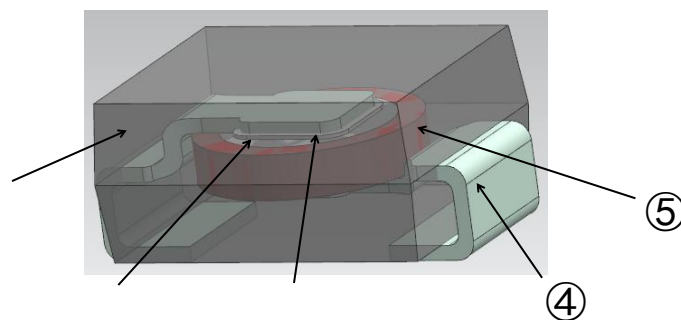

N .	P	M
①	C	E (L94 -0) (L94 -0)
②	E	/C
③		-P -A -P -A
④	L P	
⑤	D	C

5.3 / P

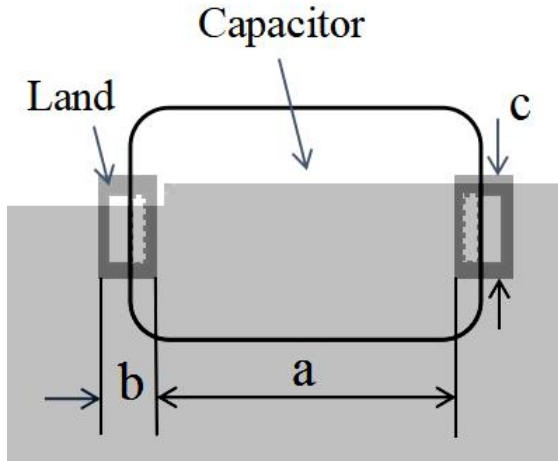

P	()	()	()
D			
4.3 3.5	4.0	2.2 0.1	3.2 0.1

6. /

6.1 /

280 °
280°C
30 °
30 °
200 °
P 200 °
180 °
P 180 °

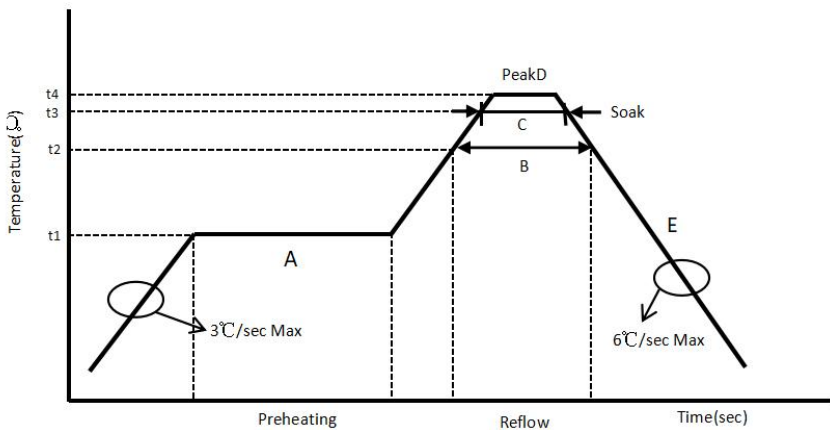

1	175 25	P	A A	120 60
2	215 10		B	110 20%
3	230 10		C C	30 20%
4	275 5	P	D D	20 10

	- 2 2 . .			
	/	-3-082	/	2021-11-15
	/	A1	/	P 9 18

6.2 /F

280 °
280°C

30 °
30

200 °
200

P 200

180 °
180

P 180

6.3 / I
PCB/P B

PCB/P B,

400
- 400

50
50

5
5

7. /

NO	I		
1	A	N L L	
2	D	5.1 5.1	

	- 2 2 . .			
	/	-3-082	/	2021-11-15
	/	A1	/	P 10 18

NO	I	
----	---	--

 TRX 专注电容器廿年	- 2 2 . .			
	/	-3-082	/	2021-11-15
	/	A1	/	P 11 18

NO	I		
8			150 180 C 90 30 P 150 180 C 90 30 . / : 230 C-260 C / : 60± 15 . / :4 15--35 45--75% H 24 2 L 15-35 , 45-75% H 24 2 , .
		NO.3 P NO.3	
	C	L:± 10% 5P:± 10% 5 :± 20% 5 :± 20%	
	D.F.	L: 1.0% 5P: 2.5% 5 : 2.5% 5 : 2.5%	
	I .	NO.7 P NO.7	
9		G	(JI K 5902) (JI K 8101) (25%) () I (JI K 8101) (JI K 5902) (25%) ()). () I 2 0.5 2 0.5 . : 245 10 C
10		N	
		NO.3 P NO.3	: +125 3
	C	L:± 10% 5P: 10% 5 : 20% 5 : 20%	: -40 3 / : 5
	D.F.	L: 1.0% 5P: 2.5% 5 : 2.5% 5 : 2.5%	30 25 3 24 2
	I .	NO.7 P NO.7	C 24 2 25 3 .

 TRX 专注电容器廿年	- 2 2 . .			
	/	-3-082	/	2021-11-15
	/	A1	/	P 14 18

NO	I		
16	C	N P NO.3 NO.7 N .3 N .7	$30 \pm 5\%$ $70 \pm 5\%$ $30 \pm 5\%$ $70 \pm 5\%$ / 23.5 5 ± 0.5 $5.0.5$. / 8
17			$30 \pm 5\%$ $70 \pm 5\%$ $30 \pm 5\%$ $70 \pm 5\%$ / 23.5 5 ± 0.5 10 $5.0.5$ 10 .

8. /

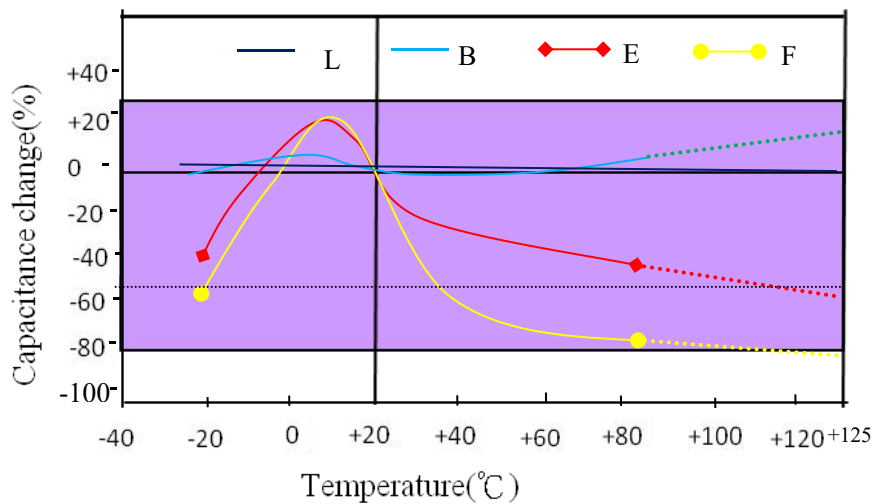

	- 2 2 . .			
	/	-3-082	/	2021-11-15
	/	A1	/	P 15 18

9. /

H 2.0 2011/65/E

EACH N 190 7/2006



	(;)
/C	<100
/L	<1000
/M	<1000
/H	<1000
PBB /P	<1000
PBDE /P	<1000
+ + + /C +P +H +C +6()	<100
/C	<900
/B	<900
+ /C +B	<1500
EACH HC H C (HC) EACH	EACH

10. /

(1).

E ; , , , ,
. A , , , , , ,

(2).

12 , 12

(3).

/ : 10 30
/H : 60% .
168

(4).

60 × 168
I 6 HIC . A
(60 168)

 TRX 专注电容器廿年	- 2 2 . .			
	/	-3-082	/	2021-11-15
	/	A1	/	P 16 18

11. /
11.1 /D

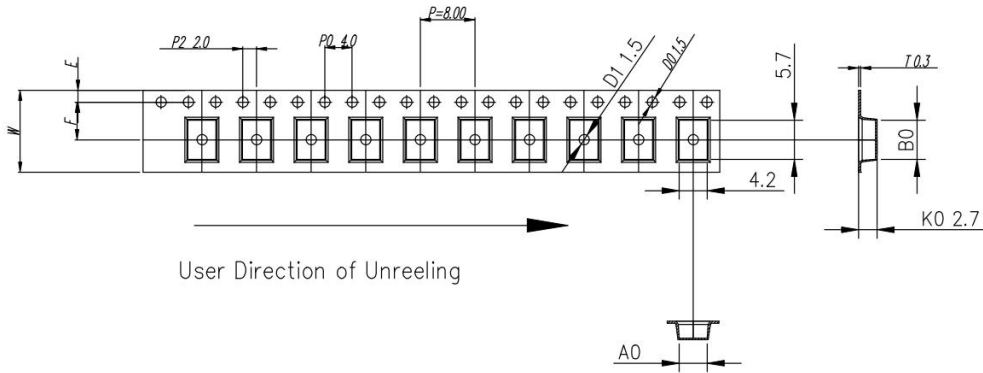

ITEM	W	A0	B0	K1	K0	P	F	E	D0	D1	P0	P2	T
DIM	12.0 ±0.30	4.2 ±0.10	5.70 ±0.10	-- ±0.10	2.70 ±0.10	8.00 ±0.10	5.50 ±0.10	1.75 ±0.10	∅1.5 ±0.05	∅1.5 ±0.10	4.0 ±0.10	2.0 ±0.10	0.30 ±0.05
ALTERNATE													

11.2 /D

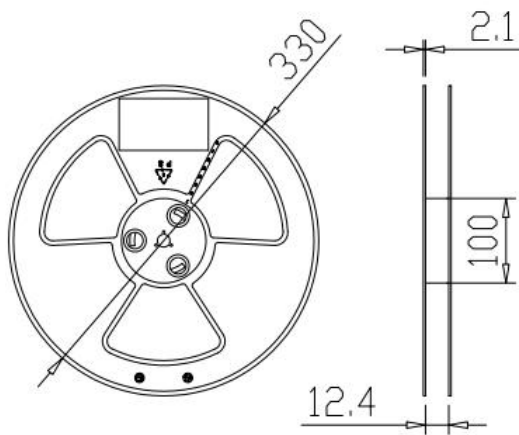

EEL	EEL I E
3000	13



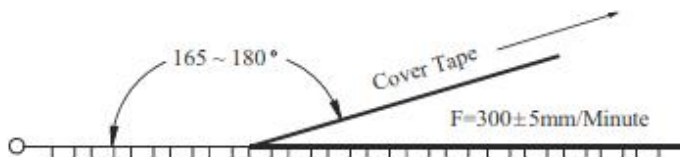

11.3 /P



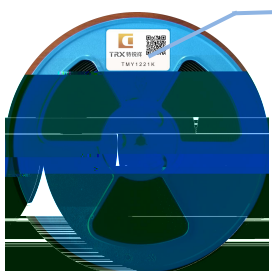

Item	Data	Remark
Cover tape adhesion	10 ~ 100g	Carrier tape and cover tape open angle 165 ~ 180° F=300±5mm/minute



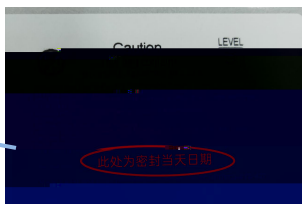

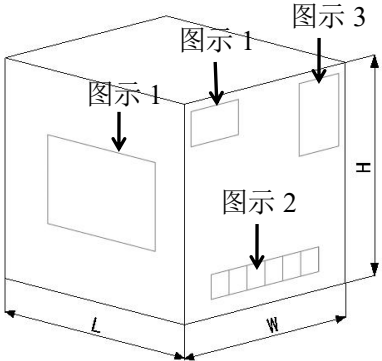

 TRX 专注电容器廿年	- 2 2 . .			
	/	-3-082	/	2021-11-15
	/	A1	/	P 17 18

11.4 /P P

 <p>标签/L</p>	 <p>料号</p>	/I
		
/P	/L	/H

															
图示 1/F 1 图示 2/F 2 图示 3/F 3	<table border="1" style="width: 100%; border-collapse: collapse;"> <tr> <td colspan="3" style="text-align: center;">D ()</td> <td colspan="2" style="text-align: center;">O B</td> </tr> <tr> <td style="text-align: center;">L</td> <td style="text-align: center;">H</td> <td rowspan="2" style="text-align: center;">45KPC</td> <td colspan="2" rowspan="2" style="text-align: center;">10.0KG</td> </tr> <tr> <td style="text-align: center;">355</td> <td style="text-align: center;">294</td> </tr> </table>			D ()			O B		L	H	45KPC	10.0KG		355	294
D ()			O B												
L	H	45KPC	10.0KG												
355	294														

			
/O B	15 / /15 /B	(/ /) P (L/ /H) 1100*1100*90	(/ /) (L/ /H) 1100*1100*1600

1. " 5" 5 2. PALLE & APPING
 3.50 :1. 5 4. / ' 5 ; 2. P & -
 ; 3.50 ; 4. N

	- 2 2 . .			
	/	-3-082	/	2021-11-15
	/	A1	/	P 18 18

12. /

①.

A

②.

PCB

PCB

PCB

C