



深圳市弗瑞鑫电子有限公司

规格承认书

—

prepare	
check	
approve	



TRX 特锐祥
特锐祥 特锐祥 特锐祥 11 年

TRX电容一级代理商

深圳市弗瑞鑫电子有限公司

Add: 深圳市宝安区西乡大道302号金源商务大厦B座3楼
Tel: 0755-29563634
Fax: 0755-27447020

SMD- 2

SMD 2 . .

/N

/D

/E

/P

	SMD- 2 SMD 2 . .		
	/N		/D
	/E		/P

 TRX 专注电容器廿年	SMD- 2 SMD 2 . .		
	/N		/D
	/E		/P

1. /P N

T B 2 102 M E
 ① ② ③ ④ ⑤ ⑥

①

	SMD- 2 SMD 2 . .		
	/N		/D
	/E		/P

3. /D



 TRX 专注电容器廿年	SMD- 2 SMD 2 . .		
	/N		/D
	/E		/P

4. /C

5. /P

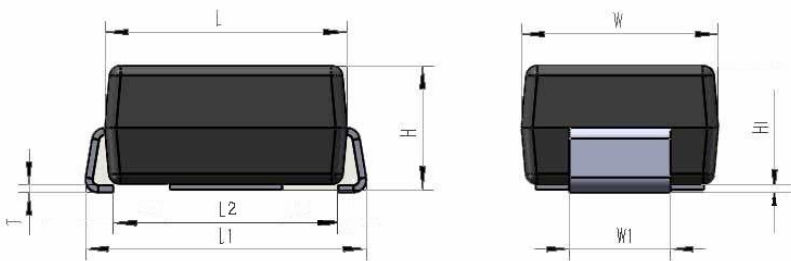

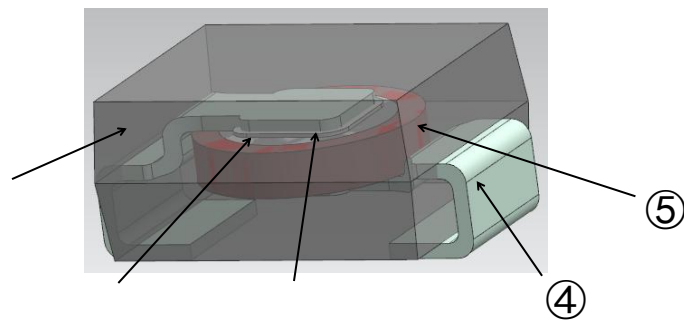

①		
②		
③		
④		
⑤		

SMD- 2
SMD 2 . .

/N

/D

/E

 TRX 专注电容器廿年	SMD- 2 SMD 2 . .		
	/N		/D
	/E		/P

/

°
°C

°

°

°

/

7. /P



SMD- 2
SMD 2 . .

/N

/D

/E

/P

					±
		±			
		±			
		±			
		±			



SMD- 2
SMD 2 . .

/N

/D

/E

/P

			±
			△ △ △ △ △
			△ △ △ △ △

 TRX 专注电容器廿年	SMD- 2 SMD 2 . .		
	/N		/D
	/E		/P

			± ±
			± ±
			± ±
			± ±

8. /C

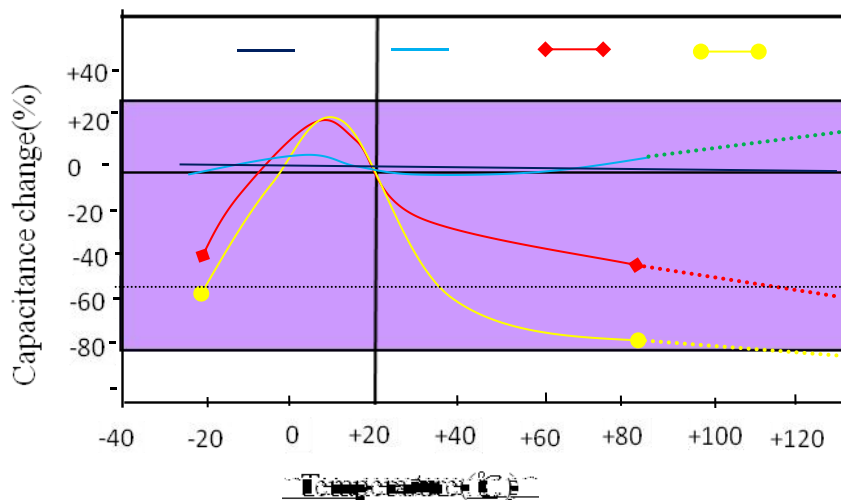

 TRX 专注电容器廿年	SMD- 2		
	SMD 2 . .		
	/N		/D
	/E		/P

11. /P P
/

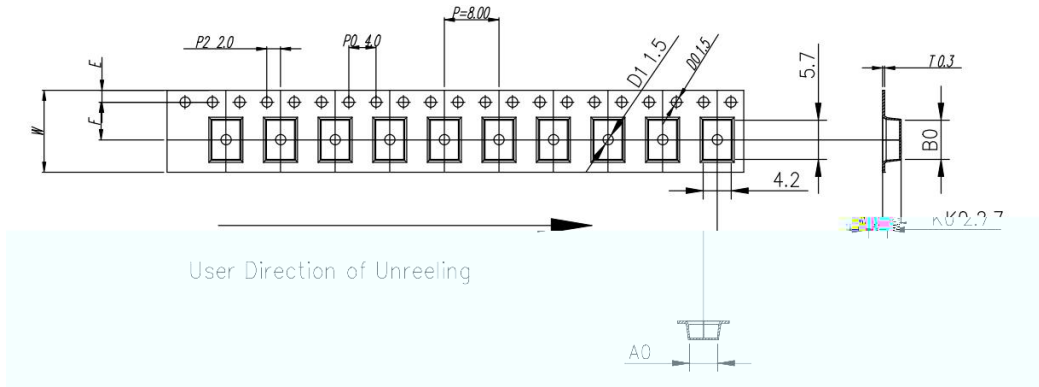

ITEM	W	A0	B0	K1	K0	P	F	E	D0	D1	P0	P2	T
DIM	12.0	± 0.30 4.2	± 0.10 5.70	--	± 0.10 2.70	± 0.10 8.00	± 0.10 5.50	± 0.10 1.75	± 0.10 $\phi 1.5$	± 0.10 $\phi 1.5$	± 0.10 4.0	± 0.10 2.0	± 0.05 0.30
ALTERNATE													

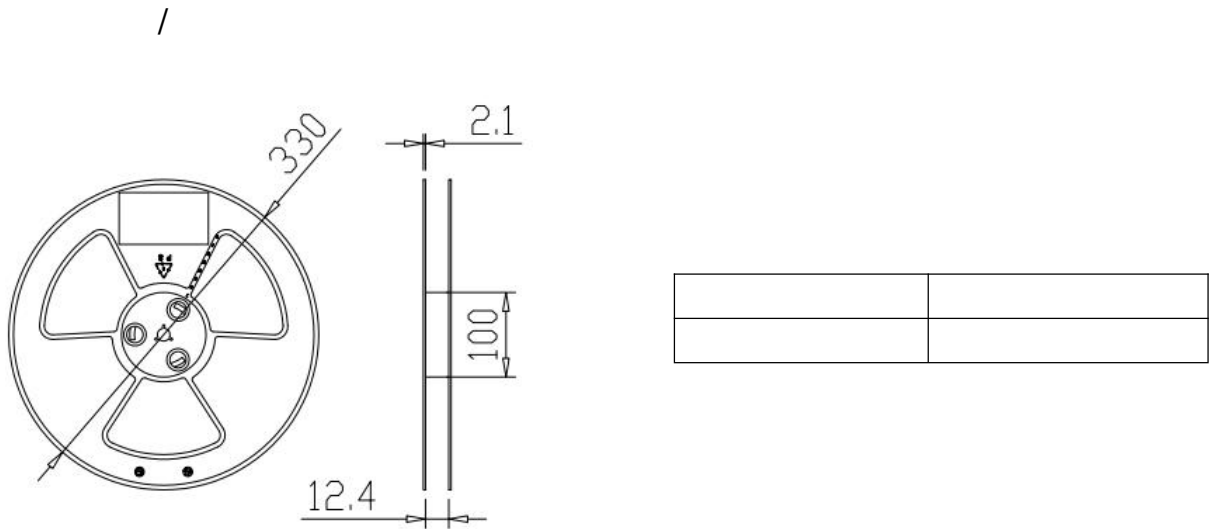

/

Item	Data	Remark
Cover tape adhesion	10 ~ 100g	Carrier tape and cover tape open angle 165 ~ 180° F=300±5mm/minute

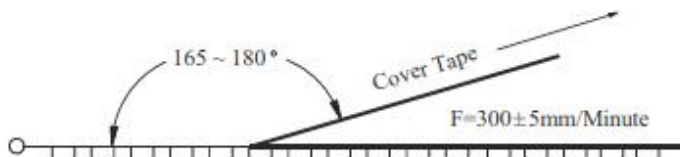

SMD- 2
SMD 2 . .



/N

/D

/E

/P

/ -

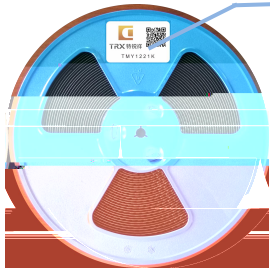

标签



料号

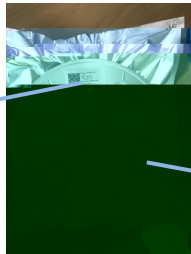
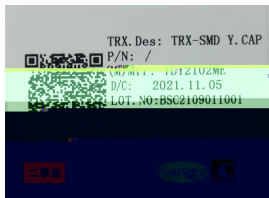

/O -

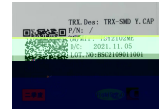
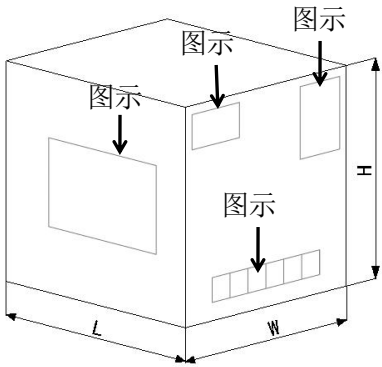

图示 /

图示 /

图示 /

/P

:



/



/



R

	SMD- 2 SMD 2 . .		
	/N		/D
	/E		/P

12. /A

①

②