



深圳市弗瑞鑫电子有限公司

规格承认书

—
————
————

prepare	
check	
approve	



TRX电容一级代理商
 深圳市弗瑞鑫电子有限公司

Add: 深圳市宝安区西乡大道302号金源商务大厦B座3楼
 Tel: 0755-29563634
 Fax: 0755-27447020

SMD Y
SMD Y1 a.c. ceramic capacitors



/Number

/Date

/Edition

/Page

 <p>TRX 专注电容器廿年</p>	SMD Y SMD Y1 a.c. ceramic capacitors		
	/Number		/Date
	/Edition		/Page

1. /Product Name





T **M** **Y1** **101** **K**
 ① ② ③ ④ ⑤

①		
②		
③		
④		
⑤		

2. /Product marking



 TRX 专注电容器廿年	SMD Y		
	SMD Y1 a.c. ceramic capacitors		
	/Number		/Date
/Edition		/Page	

/Explanation	
	
	
	
	
	

3. /Date code

↓	↓				
		↓	↓		

4. /Certificates

certificates			

5. / Product structure

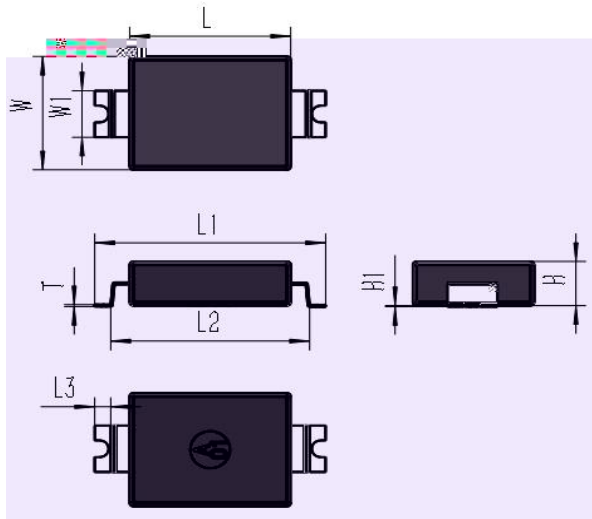

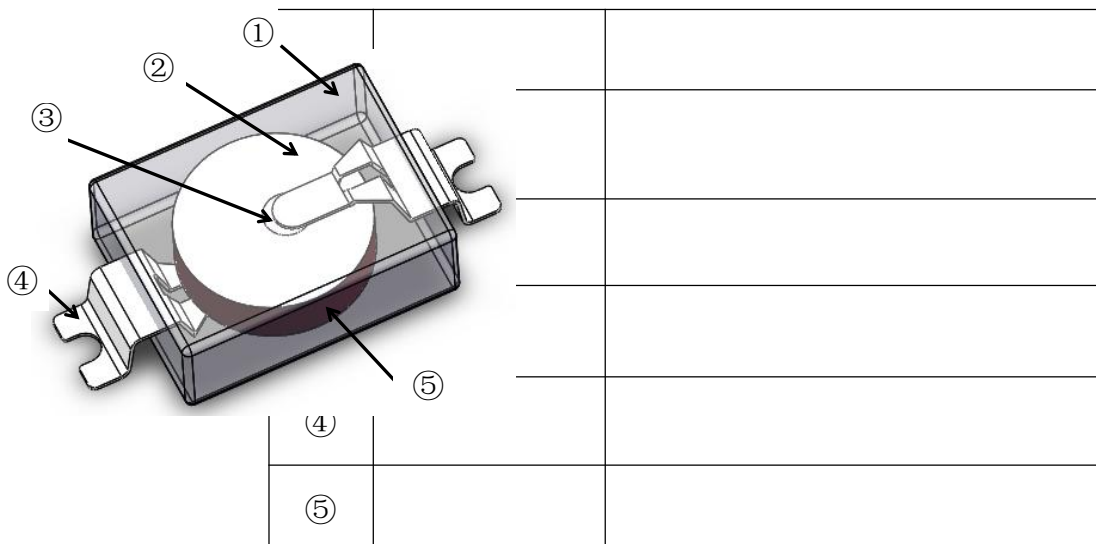



/Number

/Date

/Edition

/Page

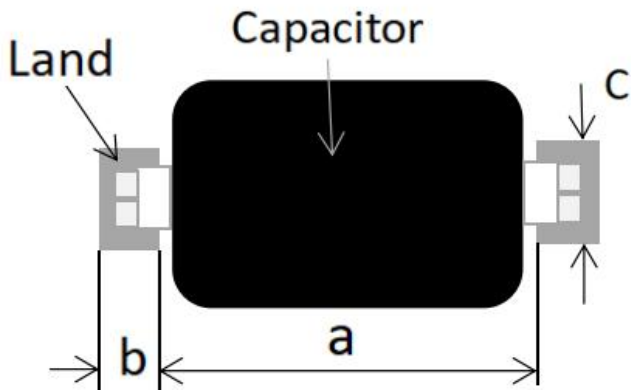

6. /Soldering condition

/

- o °C
- o
- o

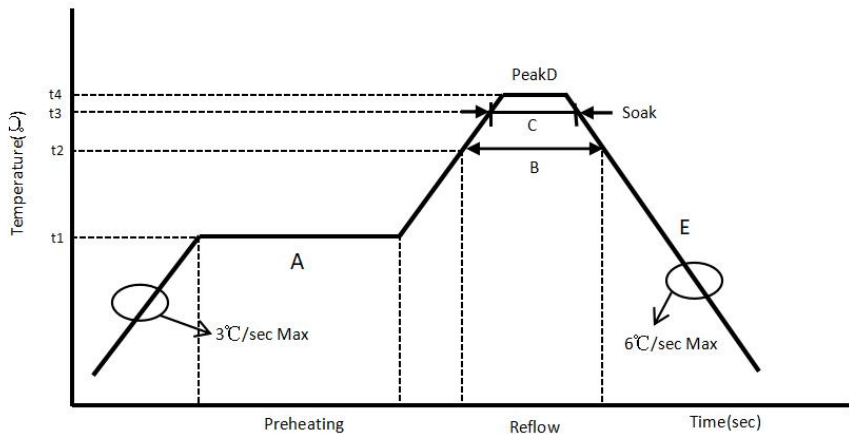

	SMD Y SMD Y1 a.c. ceramic capacitors		
	/Number		/Date
	/Edition		/Page

/

°
°C
°
°
°

/

7. / Performance and test methods

/Number		/Date	
/Edition		/Page	

			<table border="1" style="margin-left: auto;"> <tr> <td></td><td></td><td></td><td></td><td></td><td></td><td></td><td></td> </tr> <tr> <td></td><td></td><td></td><td></td><td></td><td></td><td></td><td></td> </tr> </table> <p>△</p>																



SMD Y
SMD Y1 a.c. ceramic capacitors

/Number

/Date

/Edition

/Page



SMD Y
SMD Y1 a.c. ceramic capacitors

/Number

/Date

/Edition

/Page

		△	
		△	
		△	
		△	
		△	
		△	
		△	
		△	
		△	
		△	

 TRX 专注电容器廿年	SMD Y SMD Y1 a.c. ceramic capacitors		
	/Number		/Date
	/Edition		/Page



9. /Content of toxic and harmful substances control requirements

RoHS H.F.
REACH

10. /Storage conditions

(1)

(2)

/
/

(3)

(4)

 TRX 专注电容器廿年	SMD Y SMD Y1 a.c. ceramic capacitors			
	/Number		/Date	
	/Edition		/Page	

11. /Prod

 TRX 专注电容器廿年	SMD Y SMD Y1 a.c. ceramic capacitors		
	/Number		/Date
	/Edition		/Page

/inner-packaging

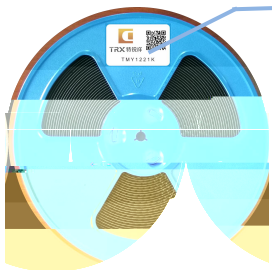

标签



料号

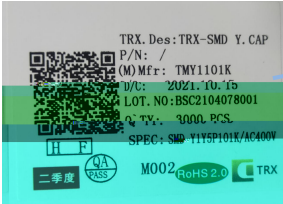

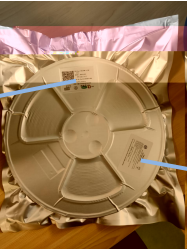

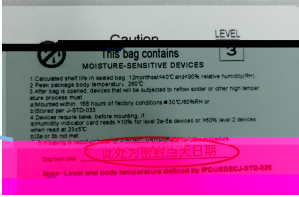

/Outer-packaging





图示 /



图示 /



图示 /

/Package sketch:



/



/





Remark

	SMD Y SMD Y1 a.c. ceramic capacitors			
	/Number		/Date	
	/Edition		/Page	

12. /Application notes

①

②

③

④

⑤

⑥