

Silicon Carbide Schottky Diode

V_{RRM}	1200V
I_F 135°C	42A
Q_C	162nC

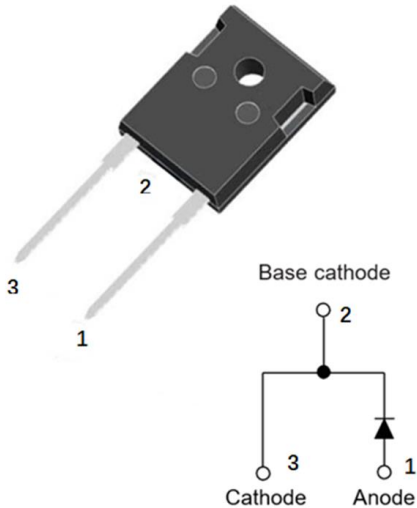

Features

- Positive temperature coefficient
- Temperature-independent switching
- Maximum working temperature at 175 °C
- Unipolar devices and zero reverse recovery current
- Zero forward recovery current
- Essentially no switching losses
- Reduction of heat sink requirements
- High-frequency operation
- Reduction of EMI

Typical Applications

Typical applications are in power factor correction(PFC), solar inverter, uninterruptible power supply, motor drives, photovoltaic inverter, electric car and charger.

Mechanical Data

Package: TO-247AC

Terminals: Tin plated leads

Polarity: As marked

Maximum Ratings ($T_C=25$ Unless otherwise specified)

PARAMETER	SYMBOL	UNIT	VALUE
Device marking code			D112030NQG2
Reverse voltage (repetitive peak) @ $T_j=25^\circ\text{C}$	V_{RRM}	V	1200
Reverse voltage (Surge Peak) @ $T_j=25^\circ\text{C}$	V_{RSM}	V	1200
Reverse voltage (DC) @ $T_j=25^\circ\text{C}$	V_{DC}	V	1200
Continuous forward current @ $T_c=25^\circ\text{C}$ $T_c=135^\circ\text{C}$ $T_c=152^\circ\text{C}$	I_F	A	94 43 30
Non-repetitive peak forward surge current @ $T_c=25^\circ\text{C}$, $t_p=10\text{ms}$, Half Sine Wave	I_{FSM}	A	225
Power Dissipation @ $T_c=25^\circ\text{C}$ $T_c=110^\circ\text{C}$	P_{TOT}	W	416 180
i^2t Value @ $T_c=25^\circ\text{C}$, $t_p=10\text{ms}$	i^2dt	A^2S	253
Operating junction and Storage temperature range	T_j, T_{stg}	$^\circ\text{C}$	-55 to +175

Electrical Characteristics

PARAMETER	SYMBOL	UNIT	TEST CONDITIONS	Typ.	Max.
Forward voltage drop	V_F	V	$I_F=30A, T_J=25^{\circ}C$	1.43	1.58
			$I_F=30A, T_J=175^{\circ}C$	1.97	
Reverse leakage current	I_R		$V_R=1200V, T_J=25^{\circ}C$	3.4	30
			$V_R=1200V, T_J=175^{\circ}C$	20.3	
Total capacitive charge	Q_C	nC	$V_R=800V, T_J=25^{\circ}C, \int_0^{V_R} C(V)dV$	162	
Total capacitance	C	pF	$V_R=0V, f=1MHZ$	2179	
			$V_R=400V, f=1MHZ$	152	
			$V_R=800V, f=1MHZ$	118	
Capacitance Stored Energy	E_C		$V_R=800V$	42	

Thermal Characteristics $T_a=25$ Unless otherwise specified

PARAMETER	SYMBOL	UNIT	VALUE
Thermal resistance	R_{jc}	$^{\circ}C/W$	0.36

Characteristics (Typical)

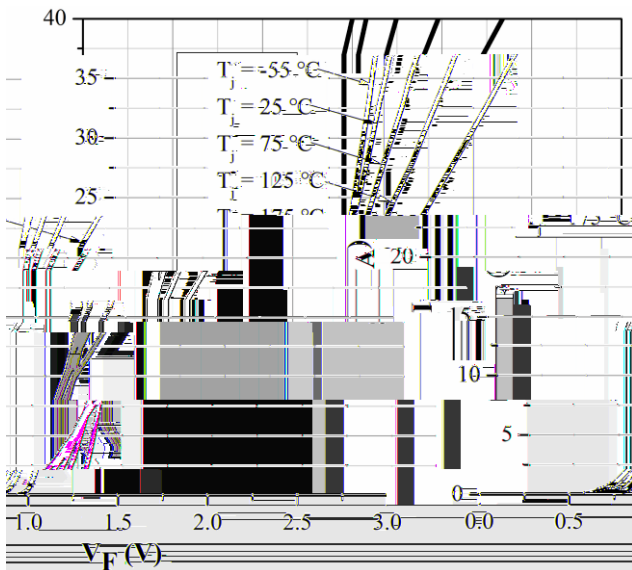

Figure 1. Forward Characteristics

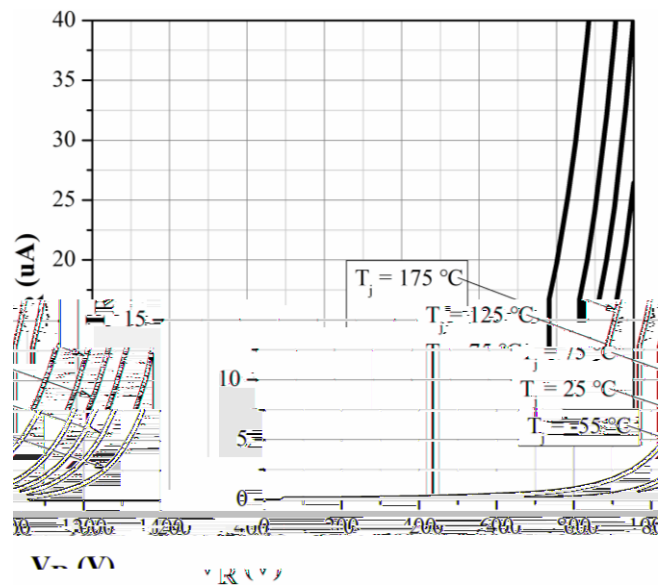

Figure 2. Reverse Characteristic

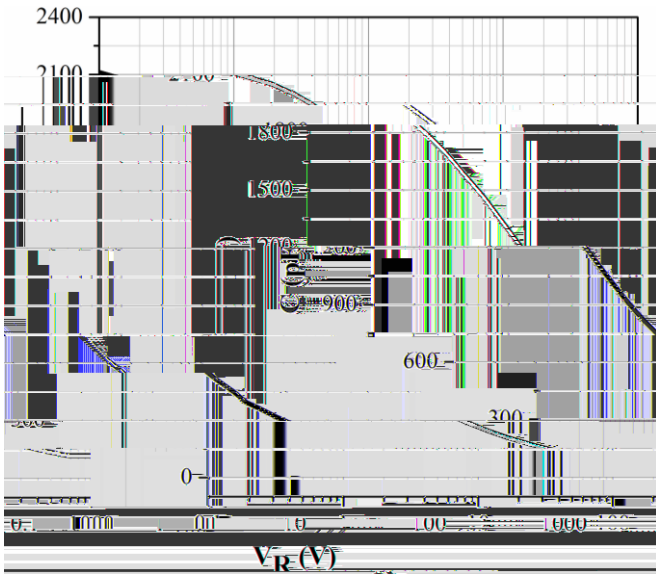

Figure 3. Capacitance vs. Reverse Voltage

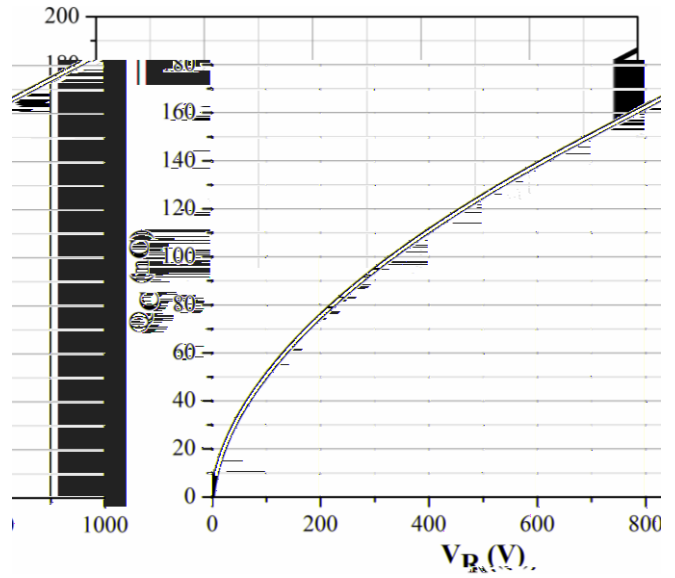

Figure 4. Total Capacitance Charge vs. Reverse Voltage

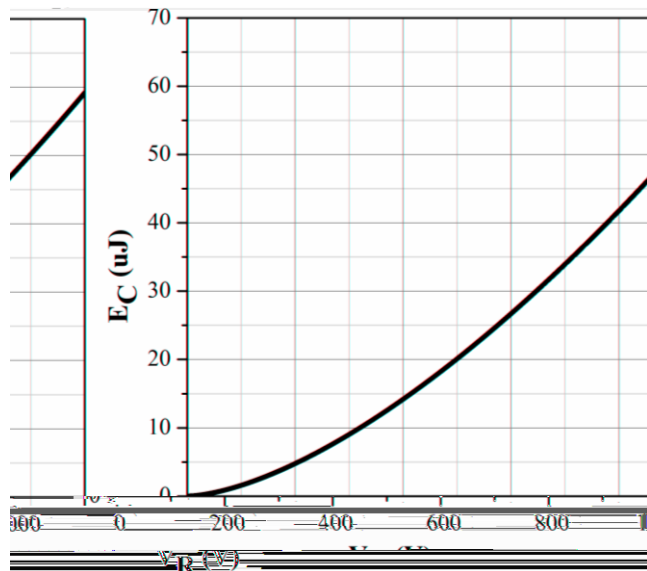

Figure 5. Capacitance Stored Energy

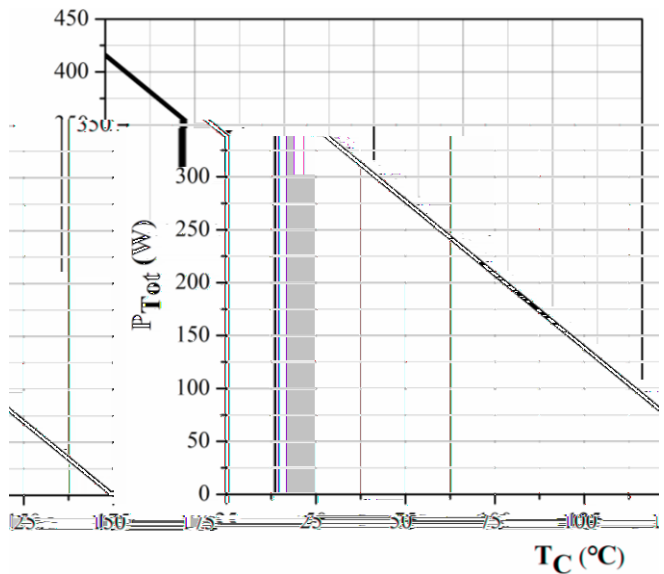

Figure 6. Power Derating

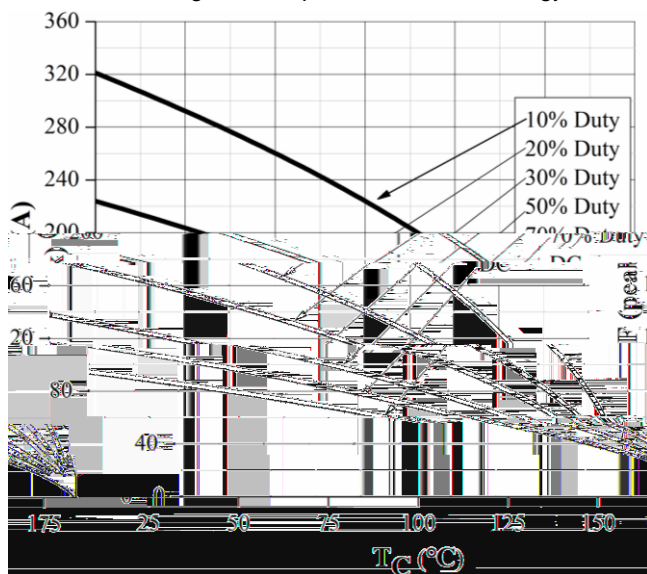

Figure 7. Current Derating

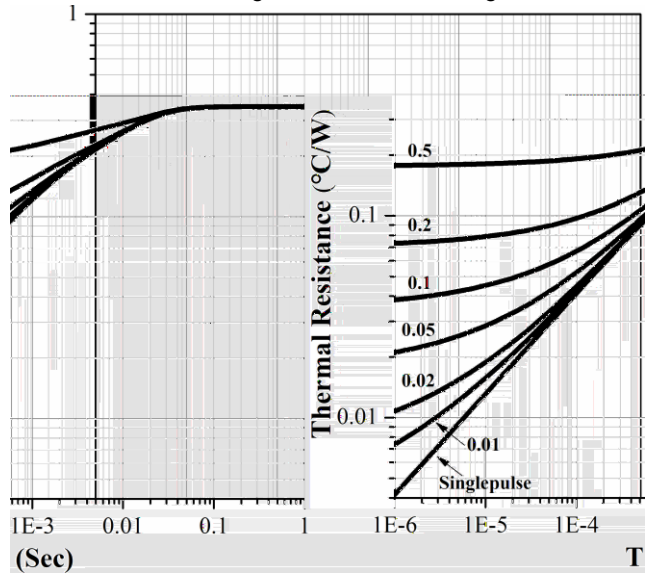
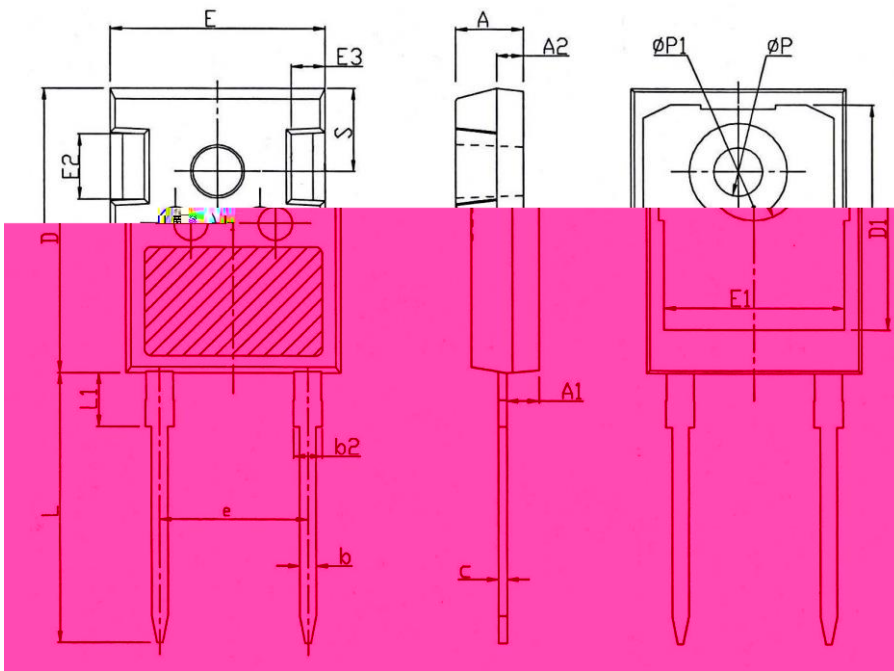

Figure 8. Transient Thermal Impedance

Outline Dimensions



TO247-AC		
Dim	Min	Max
A	4.80	5.20
A1	2.21	2.61
A2	1.85	2.15
b	1.11	1.36
b2	1.91	2.21
c	0.51	0.75
D	20.70	21.30
D1	16.25	16.85
E	15.50	16.10
E1	13.00	13.60
E2	4.80	5.20
E3	2.30	2.70
e	10.88BSC	
L	19.62	20.22
L1	-	4.30
	3.40	3.80
	-	7.30
S	6.15BSC	



Disclaimer

The information presented in this document is for reference only. Yangzhou Yangjie Electronic Technology Co., Ltd. reserves the right to make changes without notice for the specification of the products displayed herein to improve reliability, function or design or otherwise.

The product listed herein is designed to be used with ordinary electronic equipment or devices, and not designed to be used with equipment or devices which require high level of reliability and the malfunction of which would directly endanger human life (such as medical instruments, transportation equipment, aerospace machinery, nuclear-reactor controllers, fuel controllers and other safety devices), Yangjie or anyone on its behalf, assumes no responsibility or liability for any damages resulting from such improper use of sale.

This publication supersedes & replaces all information previously supplied. For additional information, please visit our website [http:// www.frxelec.com](http://www.frxelec.com), or consult your nearest Yan