



一级代理商：

深圳市弗瑞鑫电子有限公司

地址：深圳市宝安区西乡大道302号金源商务大厦B座三楼

frxelec







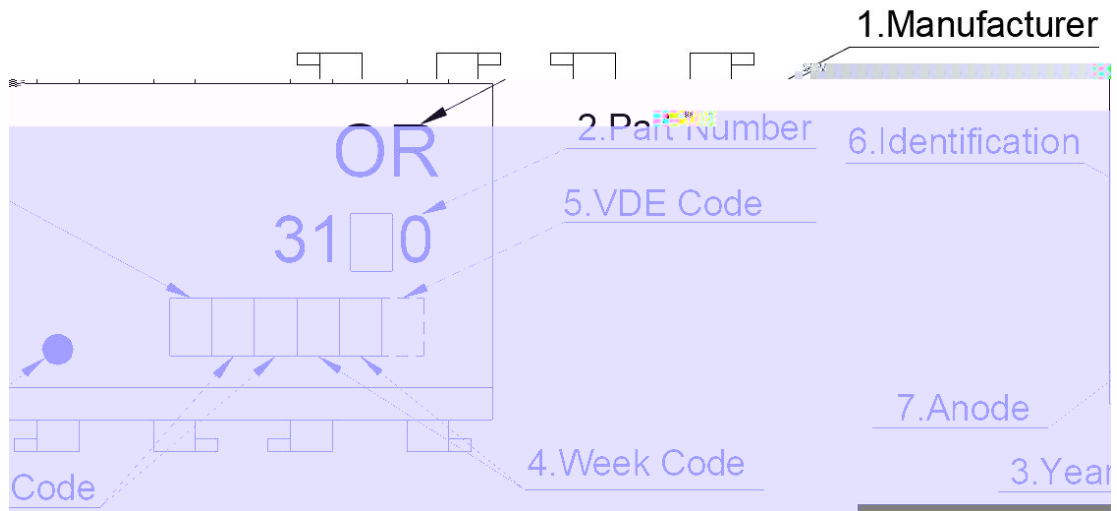

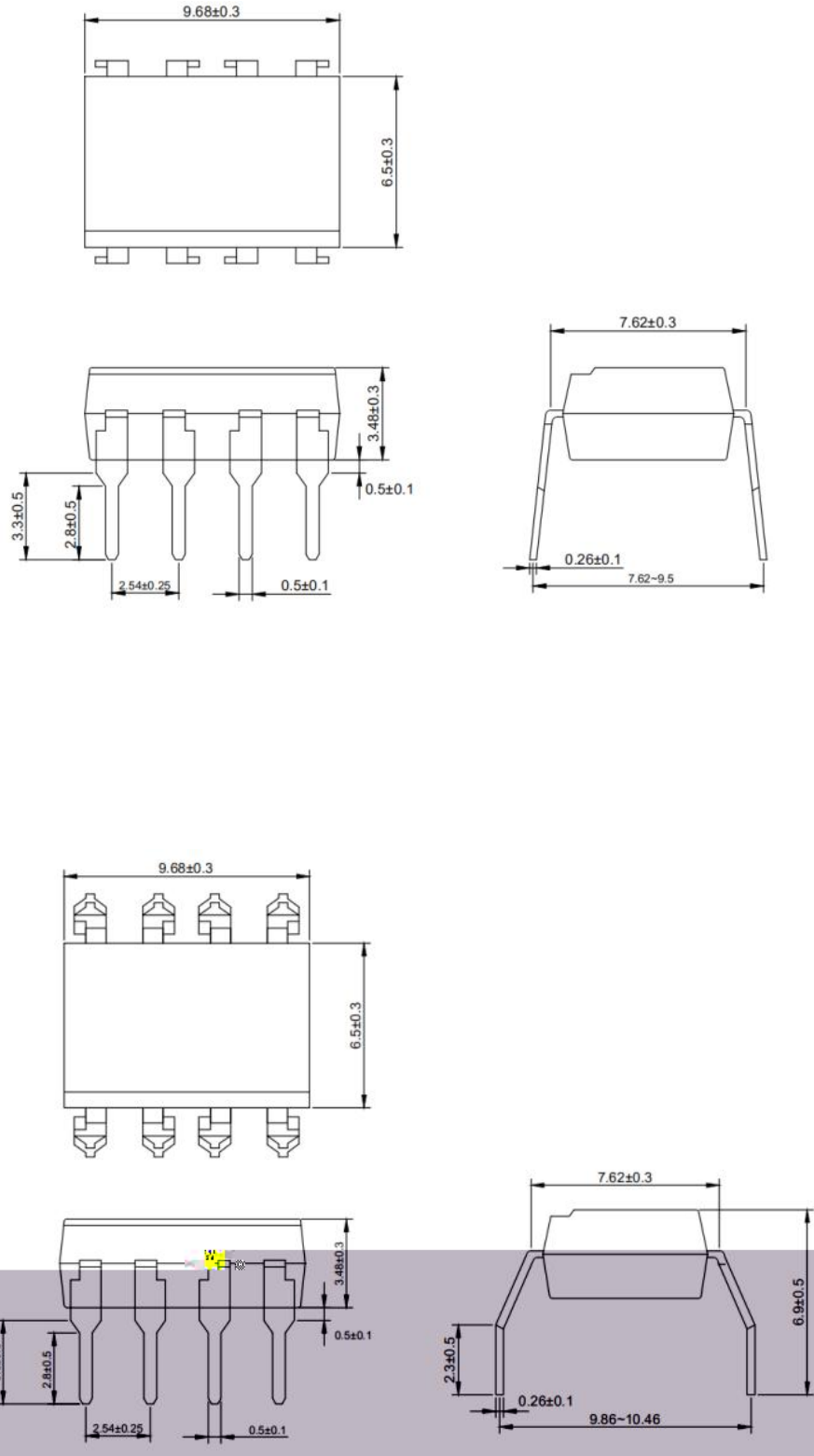

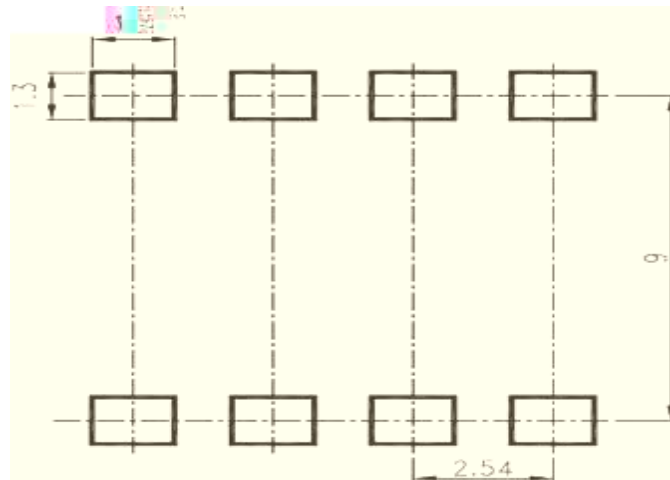
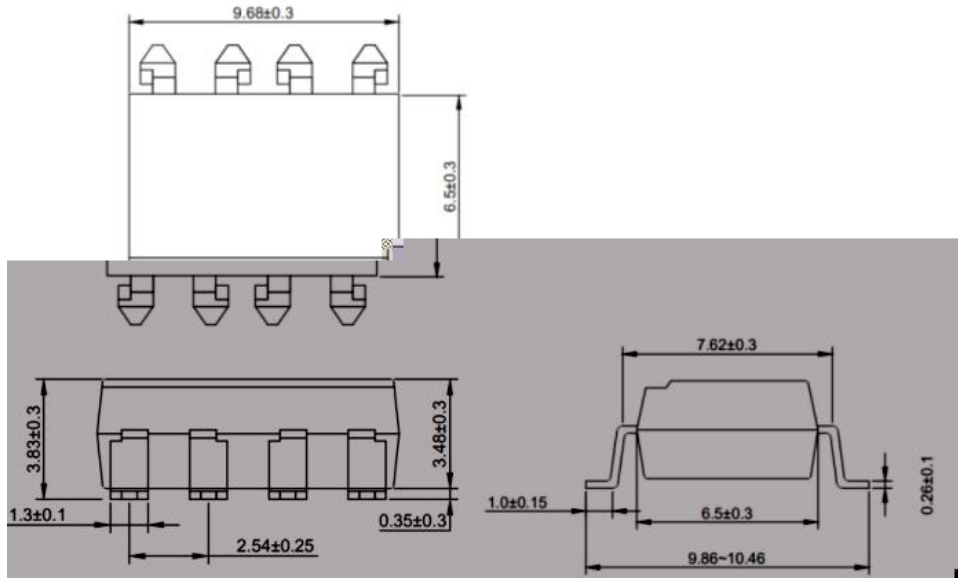





 ORIENT ShenZhen Orient Components Co.,LTD	  		
Material Code : 120PCXXXXXX P/N: OR-XXXXXX Lot No.: XXXXXX-XXXXX-TX-X 	<table border="1"><tr><td>内箱码</td><td>外箱码</td></tr></table>	内箱码	外箱码
内箱码	外箱码		

ORIENT
www.orient.com.cn
www.orient.com.cn

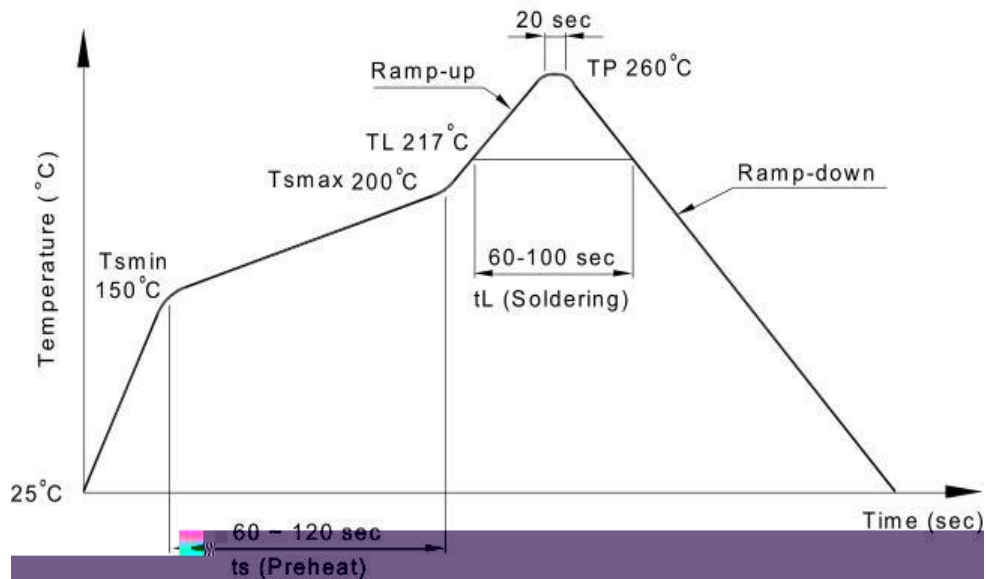





Figure 1: V_{OH} vs. Temperature

Figure 2: I_{OH} vs. Temperature

Figure 3: V_{OH} vs. I_{OH}

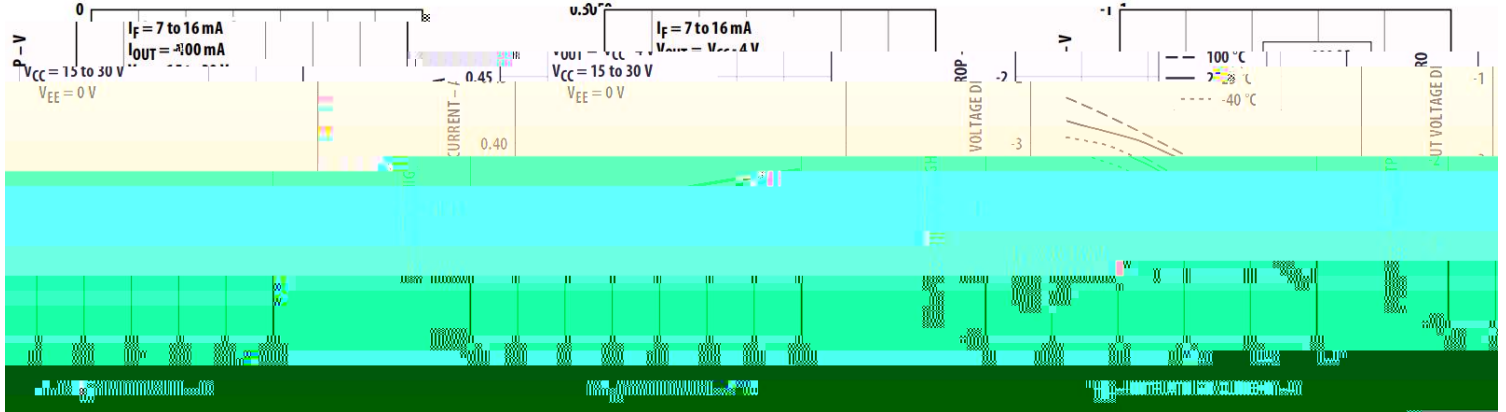

Figure 4: V_{OL} vs. Temperature

Figure 5: I_{OL} vs. Temperature

Figure 6: V_{OL} vs. I_{OL}

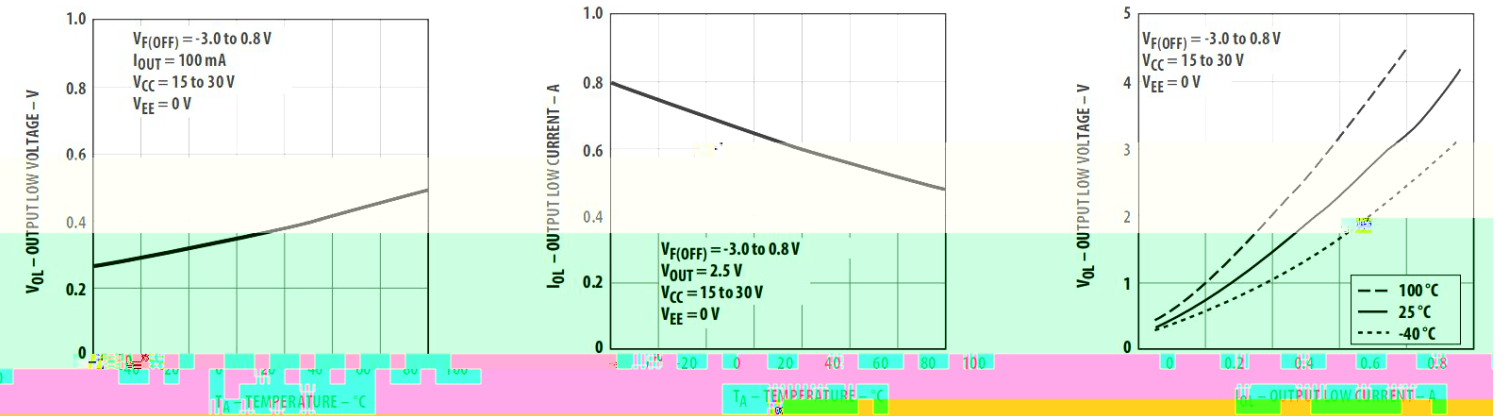

Figure 7: I_{CC} vs. Temperature

Figure 8: I_{CC} vs. V_{CC}

Figure 9: I_{FLH} vs. Temperature

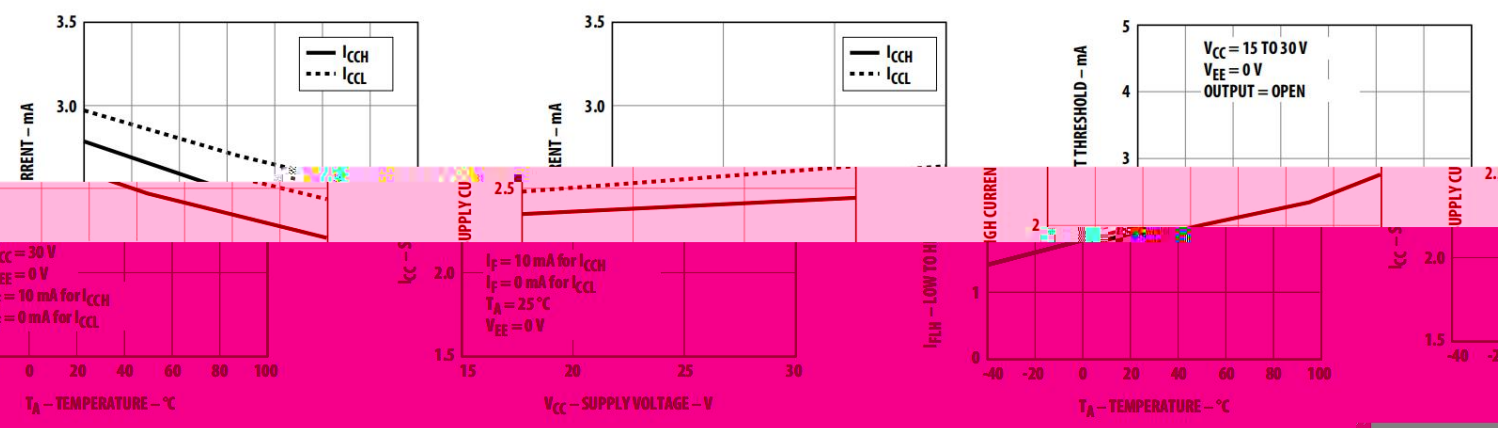



Figure 10 Propagation Delay vs. V_{CC} (OR-3120)

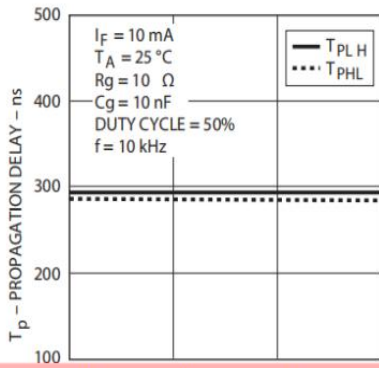

Figure 11 Propagation Delay vs. I_F (OR-3120)

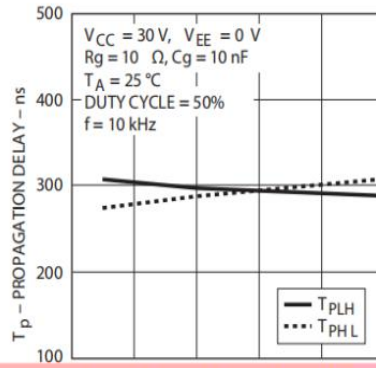
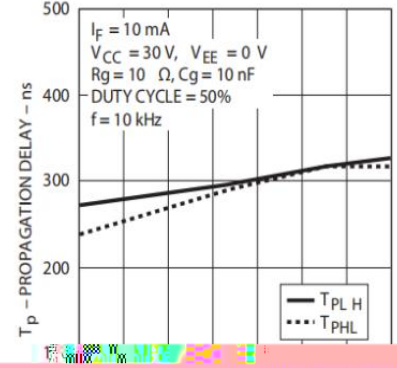
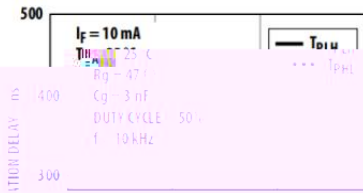

Figure 12 Propagation Delay vs. Temperature (OR-3120)



Propagation Delay vs. V_{CC} (OR-3150)



Propagation Delay vs. I_F (OR-3150)

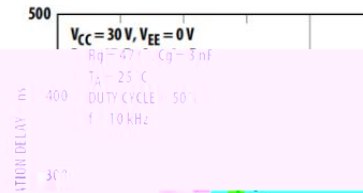

Propagation Delay vs. Temperature (OR-3150)

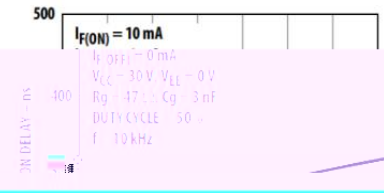

**Figure 13 Propagation Delay vs. Rg
(OR-3120)**

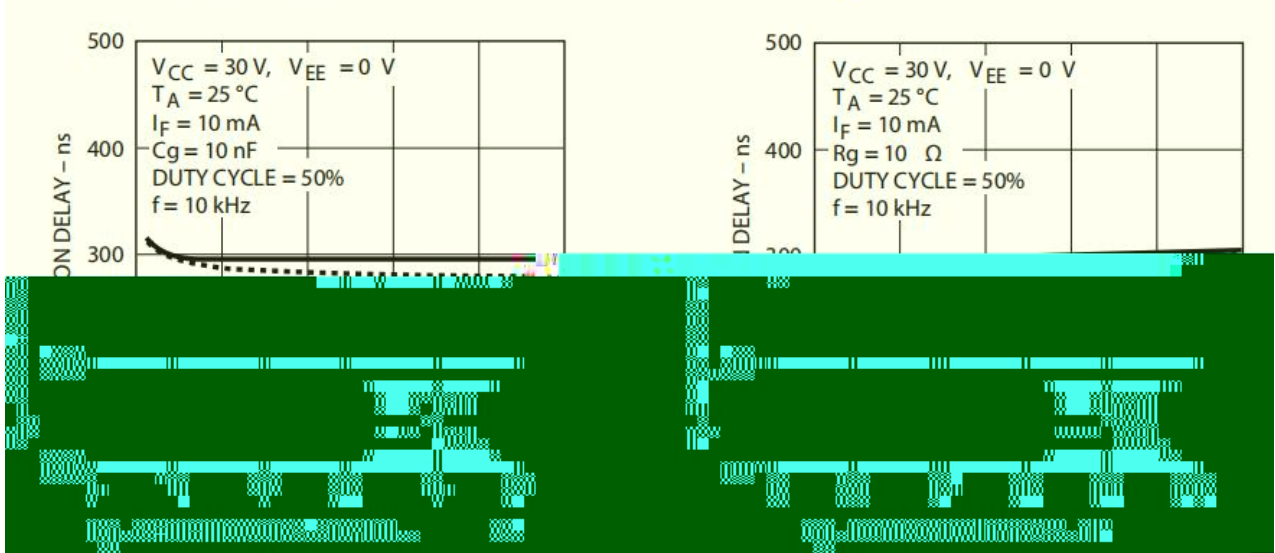

**Figure 14 Propagation Delay vs. Cg
(OR-3120)**

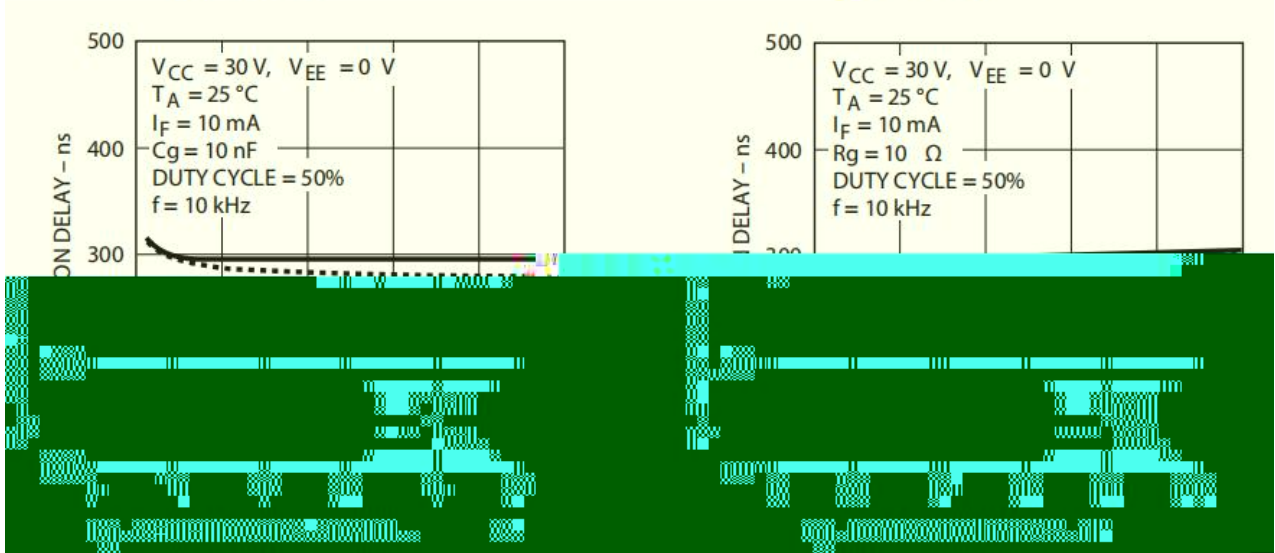

**Propagation Delay vs. Rg
(OR-3150)**

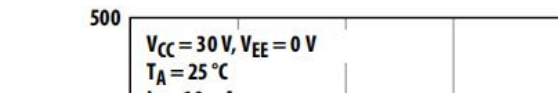

**Propagation Delay vs. Cg
(OR-3150)**

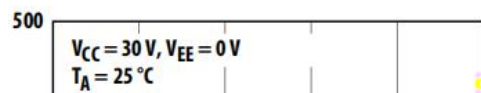

Figure 15 Transfer Characteristics

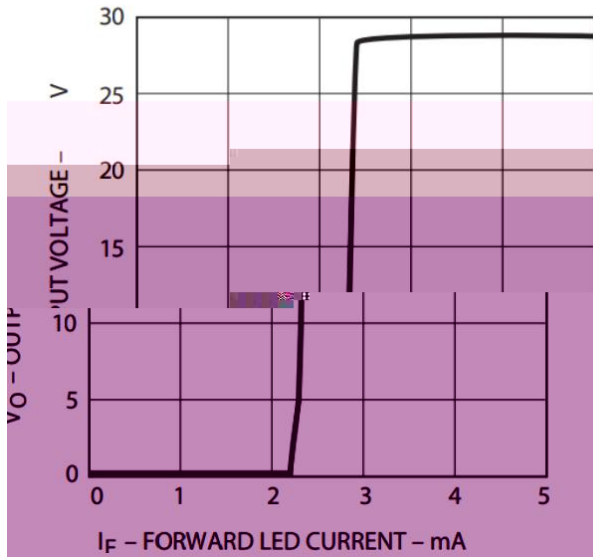

Figure 16 Input Current vs Forward Voltage

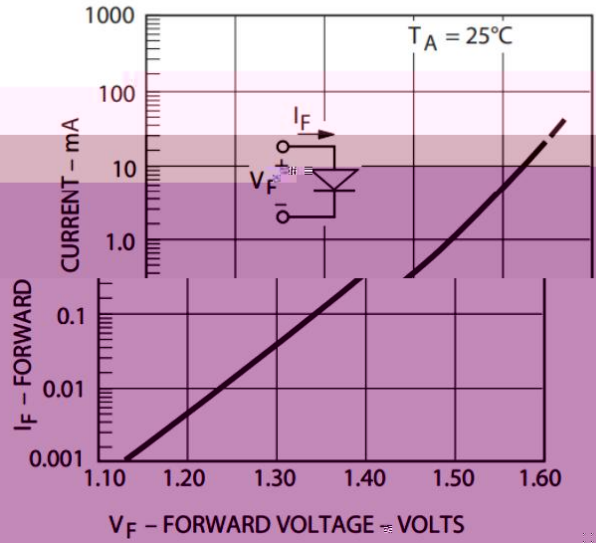

Figure 17: I_{OH} Test Circuit



Figure 18: I_{OL} Test Circuit



Figure 19: V_{OH} Test Circuit

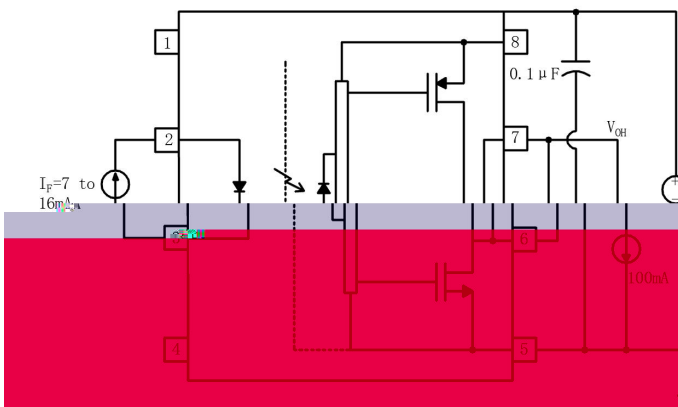

Figure 20: V_{OL} Test Circuit

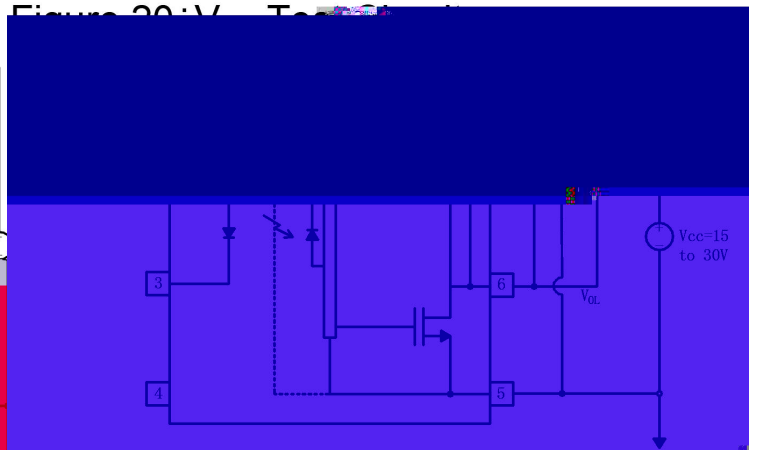

Figure 21: I_{FLH} Test Circuit

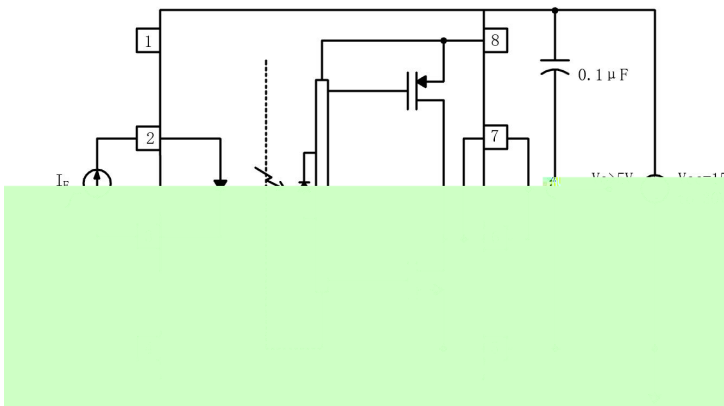

Figure 23: t_{PLH} , t_{PHL} , t_r , and t_f Test Circuit and Waveforms

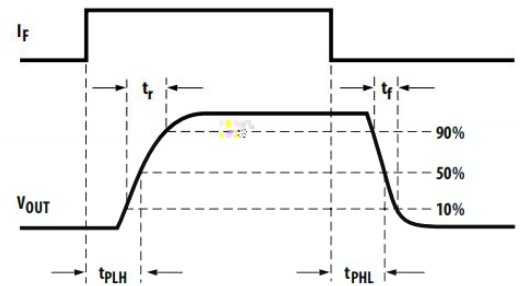
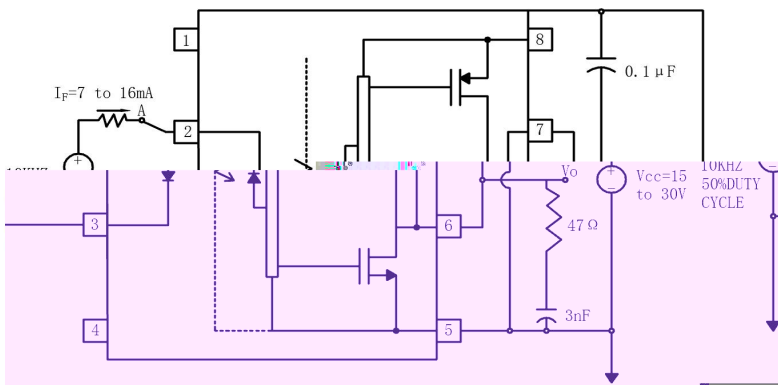

Figure 24: CMR Test Circuit and Waveforms

