



深圳市弗瑞鑫电子有限公司

规格承认书

: /
 : 单
 : 单

prepare	
check	
/	
approve	



TRX电容一级代理商
深圳市弗瑞鑫电子有限公司

Add: 深圳市宝安区西乡大道302号金源商务大厦B座3楼
 Tel: 0755-29563634
 Fax: 0755-27447020

 TRX 专注电容器廿年	SMD Y			
	SMD Y1 a.c. ceramic capacitors			
	/Number	-3-079	/Date	2022-03-10
/Edition	A5	/Page	P 3 18	

1/ attached sheet I

/

C	OME P.N.	P.N.	P	P	
1	/	M 1100J	MD- 1 L100J/AC400	7854	
2	/	M 1220J	MD- 1 L220J/AC400	7854	
3	/	M 1470J	MD- 1 L470J/AC400	7854	
4	/	M 1680J	MD- 1 L680J/AC400	7854	
5	/	M 1101K	MD- 1 5P101K/AC400	7854	
6	/	M 1221K	MD- 1 5P221K/AC400	7854	
7	/	M 1271K	MD- 1 5P271K/AC400	7854	
8	/	M 1331K	MD- 1 5P331K/AC400	7854	
9	/	M 1471K	MD- 1 5P471K/AC400	7854	
10	/	M 1471M	MD- 1 5 471M/AC400	7854	
11	/	M 1681M	MD- 1 5 681M/AC400	7854	
12	/	M 1102M	MD- 1 5 102M/AC400	7854	
13	/	M 1152M	MD- 1 5 152M/AC400	7854	
14	/	M 1222M	MD- 1 5 222M/AC400	7854	
		L	CLA I	5P/ 5 / 5	CLA II

2/ attached sheet II

TRX SMD-Y1.CAP

Capacitance Range and T.C Differentiation Unit:pF

1

1 AC :

.C	10	22	47	68	100	150	220	270	330	470	680	1000	1500	2200
L														
2B(5P)														
2E(5)														
2F(5)														
	400 .													
O	-40 125													
C	40/ 125/ 21													

1000

100H

A AC :

100H .

1000 . ,

 TRX 专注电容器廿年	SMD Y			
	SMD Y1 a.c. ceramic capacitors			
	/Number	-3-079	/Date	2022-03-10
	/Edition	A5	/Page	P 4 18

/CON EN

1.	P	N	-----	5
2.	P		-----	5-6
3.	D		-----	6
4.	C		-----	7
5.	P		-----	7-8
6.			-----	8-9
7.	P		-----	9-14
8.	C		-----	14
9.	C		-----	15
10.			-----	15
11.	P	P	-----	16-17
12.	A		-----	18

	SMD Y			
	SMD Y1 a.c. ceramic capacitors			
	/Number	-3-079	/Date	2022-03-10
	/Edition	A5	/Page	P 5 18

1. /Product Name

T M Y1 101 K
 ① ② ③ ④ ⑤

N .	C	E
①		
②	M	P (7854) (7854)
③	1	
④	101	C (: 101=10 10 ¹ =100 F)
⑤	K	/C J(5%) / K(10%) / M(20%)



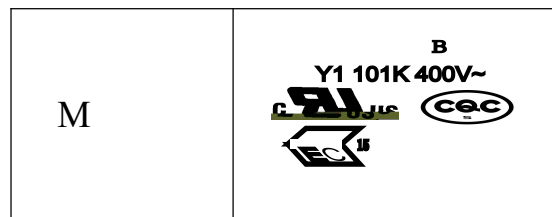

!

2. /Product marking



/D	<u>MB010806</u>
M 2020 () 2020(B))	
B H	
01 M N ()	
08 8 01-12 A (01-12)	
06 6 01-31 6 (01-31)	

	SMD Y			
	SMD Y1 a.c. ceramic capacitors			
	/Number	-3-079	/Date	2022-03-10
	/Edition	A5	/Page	P 6 18

/Explanation	
	/ /
B	/ D L / B(5P) / E(5) / F(5)
1	
101	/ C (10-2200 F : 100-222)
K	/ C J(5%)/K(10%)/M(20%)
400	L C C ENEC L C C ENEC
	L
	C C
	ENEC
	KC
250	KC KC
MB010806	D

3. /Date code

		2020	M	1	01	1	01	16	16
		2021	N	2	02	2	02	17	17
2010	A	2022	P	3	03	3	03	18	18
2011	B	2023		4	04	4	04	19	19
2012	C	2024		5	05	5	05	20	20
2013	D	2025		6	06	6	06	21	21
2014	E	2026		7	07	7	07	22	22
2015	F	2027		8	08	8	08	23	23
2016	H	2028		9	09	9	09	24	24
2017	J	2029		10	10	10	10	25	25
2018	K			11	11	11	11	26	26
2019	L			12	12	12	12	27	27
						13	13	28	28
						14	14	29	29
						15	15	30	30
								31	31

	SMD Y			
	SMD Y1 a.c. ceramic capacitors			
	/Number	-3-079	/Date	2022-03-10
	/Edition	A5	/Page	P 7 18

4. /Certificates

certificates			
C		C	C
L/C L	L/C A 60384-14	E315719	AC400 (. . .)
C C	GB/ 6346.14-2015	C C17001176740	AC400 (. . .)
ENEC	EN60384-14:2013/A1:2016	ENEC-02084	AC400 (. . .)
KC	KC 60384-14	03127-21001	AC250 (. . .)

5. / Product structure

5.1 /P D

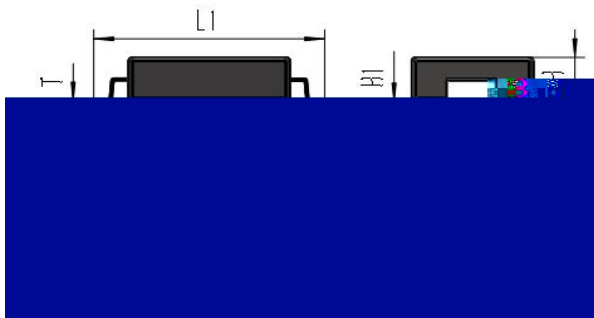
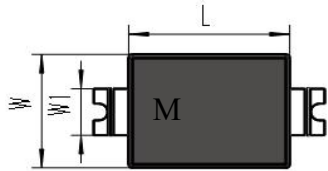

	P	D	()
L	7.8	0.1	1 2.5 0.05
	5.4	0.1	0.13 0.02
H	2.45	H1	0.05 0.03
L1	9.6	0.2	L3 0.5 0.1
L2	8.4+0.5/-0.2 ()		

5.2 /P

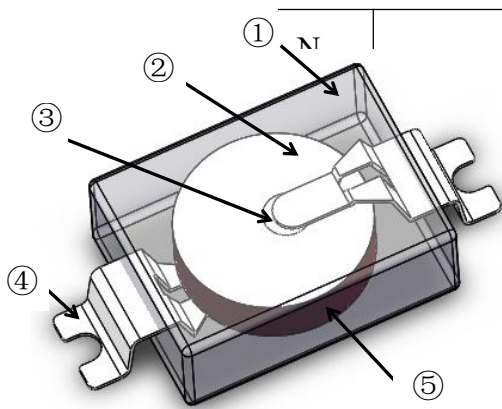

	M
E	(L94 -0)
	/C
	-P -A -P -A
④	L P
⑤	D C

5.3 / P

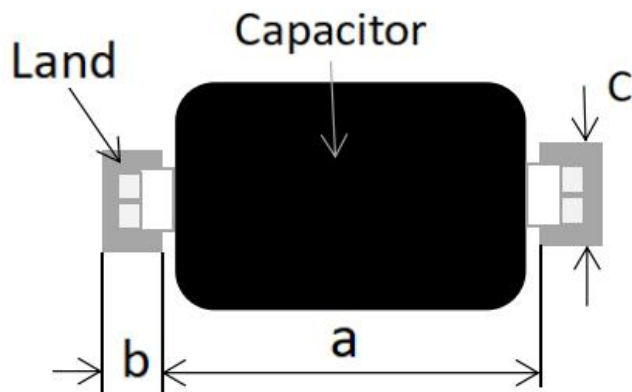

P	()	()	()
D	7.8 5.4	8.0	2.2 0.1 3.6 0.1

6. / Soldering condition

6.1 /

280 °
280°C
30 °
30 °
200 °
200 °

P

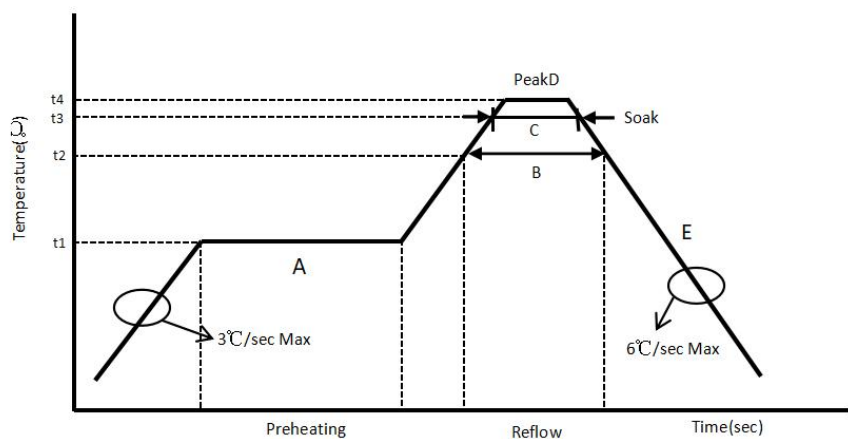

1	175 25	P	A A	120 60
2	215 10		B	110 20%
3	230 10		C C	30 20%
4	275 5	P	D D	20 10

 TRX 专注电容器廿年	SMD Y			
	SMD Y1 a.c. ceramic capacitors			
	/Number	-3-079	/Date	2022-03-10
	/Edition	A5	/Page	P 9 18

6.2 /F

280 °
280°C

30 °
30

200 °
200

P 180 °
P 180

6.3 / I
PCB/P B

PCB/P B,

400
- 400

50
50

5
5

7. / Performance and test methods

NO	I		
1	A	N L L	
2	D	5.1 5.1	

 TRX 专注电容器廿年	SMD Y			
	SMD Y1 a.c. ceramic capacitors			
	/Number	-3-079	/Date	2022-03-10
/Edition	A5	/Page	P 10 18	

NO **I**

3 B N / : 4000 AC
 / : 50/60H
 / : 60
 / : 5 A

 B N / : 4000 AC
 / : 50/60H
 / : 60
 / : 5 A

4 C J: 5% / : 25 3
 K: 10% /H : 55 30% H
 M: 20% / : 1.0 0.2
 C I(L): 1 0.2MH
 C II(5P, 5 , 5): 1 0.2KH

5 D.F. L: 1.0% / : 25 3
 5P: 2.5% /H : 55 30% H
 5 : 2.5% / : 1.0 0.2
 5 : 2.5% /F :
 C I(L): 1 0.2MH
 C II(5P, 5 , 5): 1 0.2KH

6 CC L:+140 -1000(/) / CC: 2
 5P: 10% 1 2 3 4 5
 5 : +22% -56% () +20 -25 +20 +85 +2
 5 : +22% -82%



SMD Y
SMD Y1 a.c. ceramic capacitors

/Number	-3-079	/Date	2022-03-10
/Edition	A5	/Page	P 11 18

NO	I			
8	C			150 180 C 90 30 P 150 180 C 90 30 . / . : 230 C-260 C / : 60 15 . / : 4 15--35 45--75% H 24 2 L 15-35 , 45-75% H 24 2 , .
		NO.3 P NO.3		
		L: 5% 5P: 10% 5 : 20% 5 : 20%		
		L: 1.0% 5P: 2.5% 5 : 2.5% 5 : 2.5%	D.F.	
		NO.7 P NO.7	I .	
9				(JI K 8101) (JI K 5902) () 25%) () I (JI K 8101) (JI K 5902) (25%) . () I 2 0.5 2 0.5 . . : 245 10 C
10	C	A	N	
			NO.3 P NO.3	: +125 3 : -40 3
		L: 5% 5P: 10% 5 : 20% 5 : 20%		/ : 5
		L: 1.0% 5P: 2.5% 5 : 2.5% 5 : 2.5%	D.F.	30 25 3 24 2 C 25 3 24 2 .
		NO.7 P NO.7	I .	

 TRX 专注电容器廿年	SMD Y			
	SMD Y1 a.c. ceramic capacitors			
	/Number	-3-079	/Date	2022-03-10
/Edition	A5	/Page	P 12 18	

NO	I			
11			C L: 5% 5P: 10% 5 : 15% 5 : 15% DF 2.5%	F : 10 55 10H / :1.5 6 6 2 2
12	() D ()		N	/ : 40 2
		C	$\Delta=(C -C_0)/C_0$ L Δ : 5% 5P Δ : 10% 5 Δ : 15% 5 Δ : 15%	/ : 95 3% H / : 21 : (400) : A (400)
			NO.3 P NO.3	24 2 25 3
		I .	3000M	24 2 25 3
13	E		N	8K 3 8K / : 125 3
		C	$\Delta=(C -C_0)/C_0$ L Δ : 5% 5P Δ : 10% 5 Δ : 15% 5 Δ : 15%	/D : 1000+24 -0 : 680 AC 1.7 1000 0.1 : 680 AC 1.7
			NO.3 P NO.3	1000 . . . 0.1 . 47 5%
		I .	3000M	47 5%. 25 3 24 2 C 25 3 24 2

 TRX 专注电容器廿年	SMD Y			
	SMD Y1 a.c. ceramic capacitors			
	/Number	-3-079	/Date	2022-03-10
/Edition	A5	/Page	P 13 18	

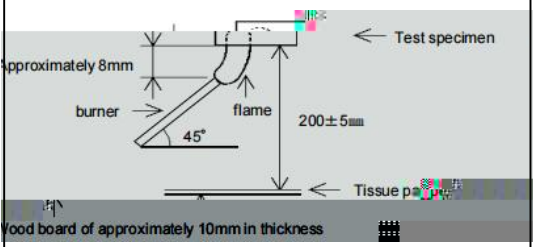
NO	I		
14	I	N	
		I	P : 8.0K
		I 24 3	I : 10
		I 24 3	I : 24
15	P		30 E : 30 /L : 12 1 35 G : L 35 /I : 0.5 0.1 /O : 0.9 95% G : B 95%
			 <p>wood board of approximately 10mm in thickness</p>

 TRX 专注电容器廿年	SMD Y		
	SMD Y1 a.c. ceramic capacitors		
	/Number	-3-079	/Date
/Edition	A5	/Page	P 14 18

NO	I	
----	---	--

30 5% 70 5%

16 C N .

P NO.3 NO.7 N .3 N .7

	SMD Y			
	SMD Y1 a.c. ceramic capacitors			
	/Number	-3-079	/Date	2022-03-10
	/Edition	A5	/Page	P 15 18

9. /Content of toxic and harmful substances control requirements

H 2.0 2011/65/E

EACH N 190 7/2006



	(:)
/C	<100
/L	<1000
/M	<1000
/H	<1000
PBB /P	<1000
PBDE /P	<1000
+ + + /C +P +H +C +6()	<100
/C	<900
/B	<900
+ /C +B	<1500
EACH H C HC (HC) EACH	EACH

10. /Storage conditions

(1).

E ; , , ,
 . A , , , , ,

(2).

/ : 10 30
 /H : 60% .

(3).

168
 - 168 HIC - . A

(4).

60 168
 I 6 (60 168) HIC





 TRX 专注电容器廿年	SMD Y		
	SMD Y1 a.c. ceramic capacitors		
	/Number	-3-079	/Date
/Edition	A5	/Page	P 16 18



11. /Prodx a

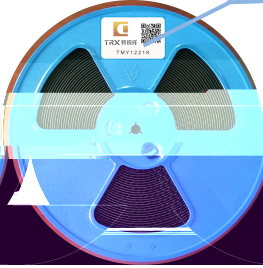

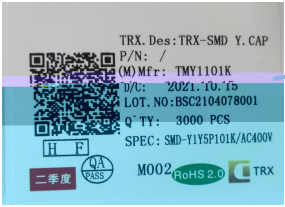

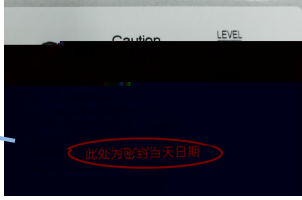
Prx

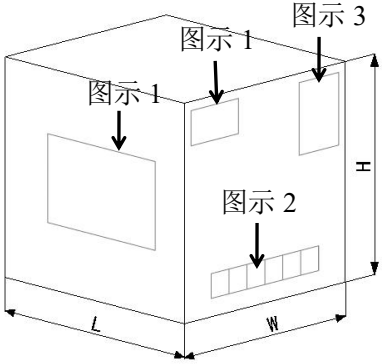
 TRX 专注电容器廿年	SMD Y			
	SMD Y1 a.c. ceramic capacitors			
	/Number	-3-079	/Date	2022-03-10
/Edition	A5	/Page	P 17 18	

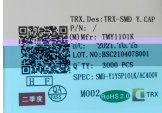
11.4 /P P

/inner-packaging		/I	
 <p>标签/L</p>	 <p>料号</p>	.D	
<p>3.0KPC /</p>	<p>/I</p>	P/N	
		M	
<p>/P</p>	<p>/L</p>	D/C	
	 <p>此处为密封当天日期</p>	L .N	
	<p>/H</p>	PEC	

/Outer-packaging			
			
图示 1/F 1	图示 2/F 2	图示 3/F 3	
D ()		O B	
L	H	42KPC	
355	358	18KG	

/Package sketch:			
			
/O B	14 / /14 /B	(/ /)	(/ /)
		P (L/ /H)	(L/ /H)
		1100*1100*90	1100*1100*1600
1.	5	2. PALLE &	APPING
3. 50	4. /	5 ; 2. P	& -
Remark:1.	5	; 3.50	; 4. N

 TRX 专注电容器廿年	SMD Y		
	SMD Y1 a.c. ceramic capacitors		
	/Number	-3-079	/Date
/Edition	A5	/Page	P 18 18

12. /Application notes

①.

A

②.

PCB PCB

PCB

C

(PCB)

PCB

PCB

③.

A

④.

P

⑤.

PCB

D

⑥.

PCB

D

PC