

V_{RRM}	650V
I_F 135°C	26A ⁽²⁾
Q_C	60nC ⁽²⁾

Positive temperature coefficient
 Temperature-independent switching
 Maximum working temperature at 175 °C
 Unipolar devices and zero reverse recovery current
 Zero forward recovery current
 Essentially no switching losses
 Reduction of heat sink requirements
 High-frequency operation
 Reduction of EMI

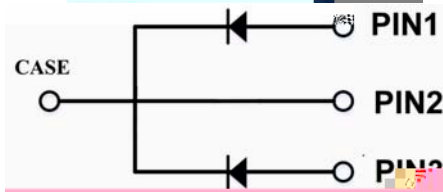
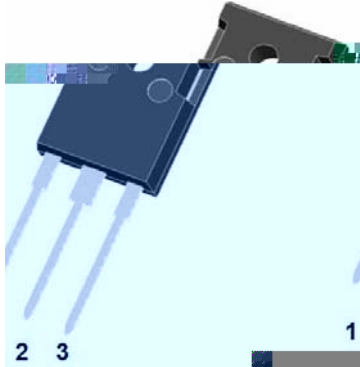

Typical applications are in power factor correction(PFC), solar inverter, uninterruptible power supply, motor drives, photovoltaic inverter, electric car and charger.

: TO-247AB

Molding compound meets UL 94 V-0 flammability rating, RoHS-compliant, halogen-free

: Tin plated leads

: As marked

($T_C=25$ Unless otherwise specified)

Device marking code			D106520NCTQG2
Reverse voltage (repetitive peak) @ $T_j=25^\circ\text{C}$	V_{RRM}	V	650
Reverse voltage (Surge Peak) @ $T_j=25^\circ\text{C}$	V_{RSM}	V	650
Reverse voltage (DC) @ $T_j=25^\circ\text{C}$	V_{DC}	V	650
Continuous forward current @ $T_c=25^\circ\text{C}$	I_F	A	27/54
Continuous forward current @ $T_c=135^\circ\text{C}$			13/26
Continuous forward current @ $T_c=150^\circ\text{C}$			10/20
Non-repetitive peak forward surge current @ $T_c=25^\circ\text{C}$, $t_p=10\text{ms}$, Half Sine Wave	I_{FSM}	A	80 ⁽¹⁾
Power Dissipation @ $T_c=25^\circ\text{C}$	P_{TOT}	W	112/230
Power Dissipation @ $T_c=110^\circ\text{C}$			48/100
i^2t Value @ $T_c=25^\circ\text{C}$, $t_p=10\text{ms}$	i^2dt	A ² S	32 ⁽¹⁾
Operating junction and Storage temperature range	T_j, T_{stg}	°C	-55 to +175

(1) Per Leg, (2) Per Device



(Per Leg)

Forward voltage drop	V_F	V	$I_F=10A, T_J=25^\circ C$	1.35	1.55
			$I_F=10A, T_J=175^\circ C$	1.8	-
Reverse leakage current	I_R	μA	$V_R=650V, T_J=25^\circ C$	0.5	25
			$V_R=650V, T_J=175^\circ C$	2	-
Total capacitive charge	Q_C	nC	$V_R=400V, T_J=25^\circ C, Q_C=\int_0^{V_R} I_C(V)dV$	30	-
Total capacitance	C	μF	$V_R=0V, f=1MHz$	543	-
			$V_R=200V, f=1MHz$	55	-
			$V_R=400V, f=1MHz$	52	-
Capacitance Stored Energy	E_C	μJ	$V_R=400V$	3.7	-

($T_a=25$ Unless otherwise specified)

Thermal resistance	R_{J-C}	$^\circ C/W$	1.34 ⁽¹⁾ 0.65 ⁽²⁾

(1) Per Leg, (2) Per Device

(Per Leg)

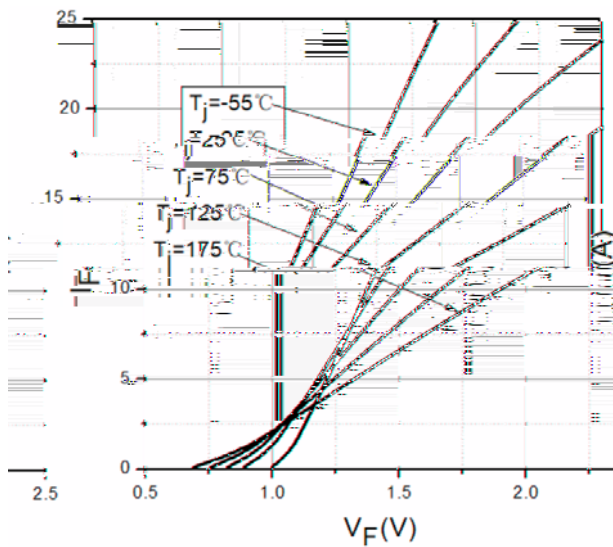

Figure 1. Forward Characteristics

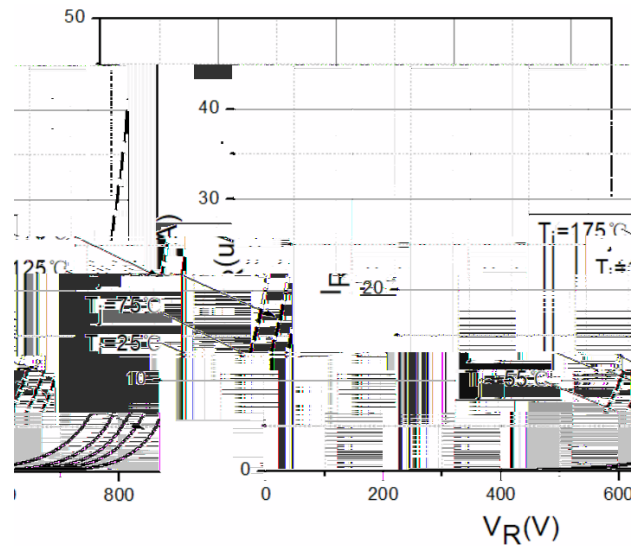

Figure2. Reverse Characteristic

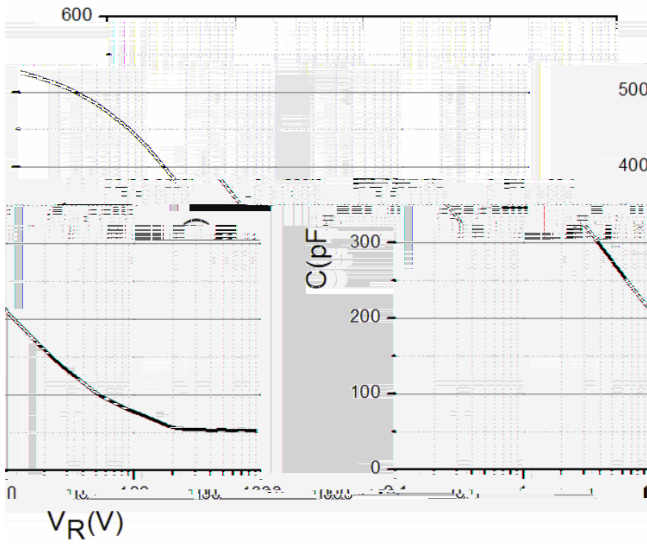

Figure 3. Capacitance vs. Reverse Voltage

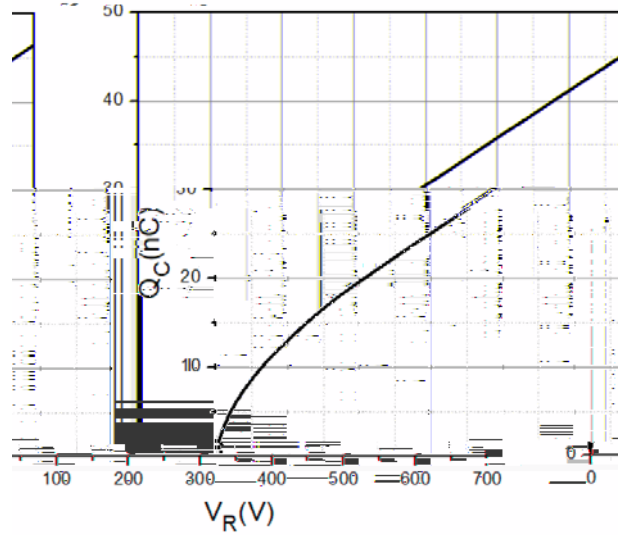

Figure 4. Total Capacitance Charge vs. Reverse Voltage

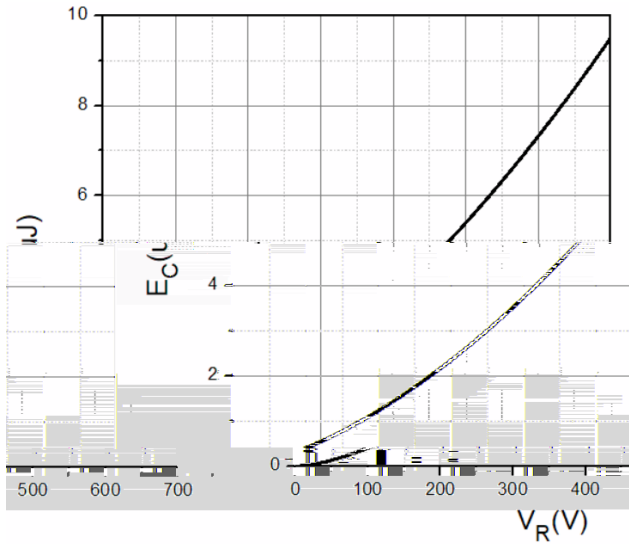

Figure 5. Capacitance Stored Energy

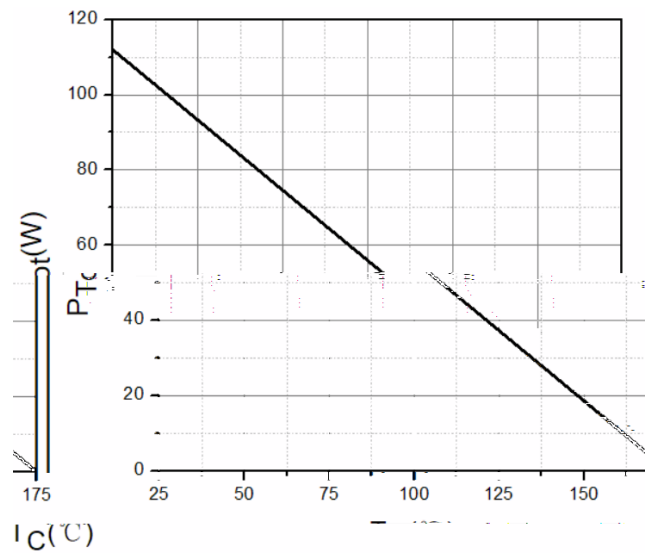

Figure 6. Power Derating

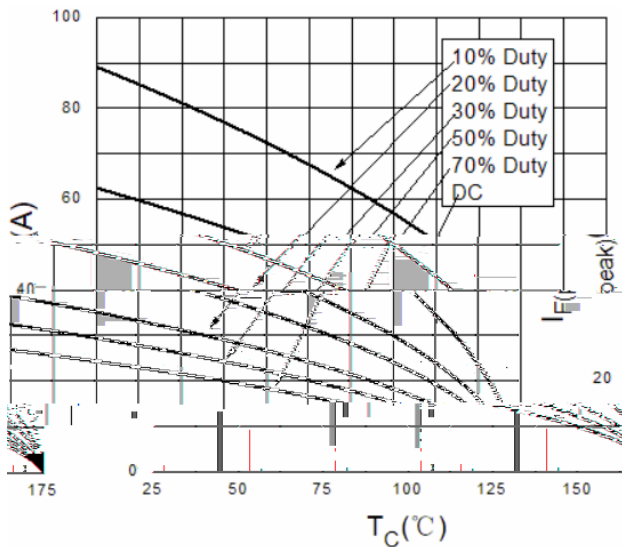

Figure 7. Current Derating

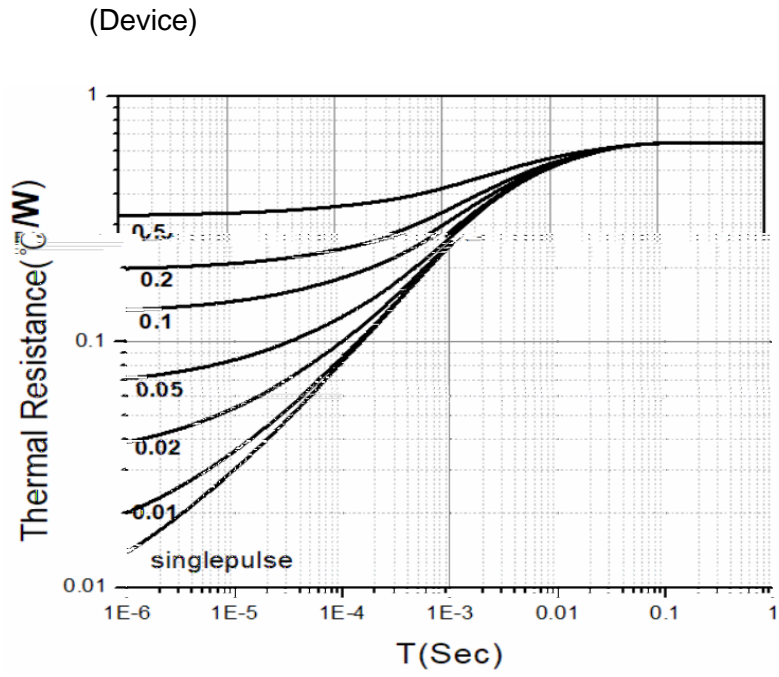
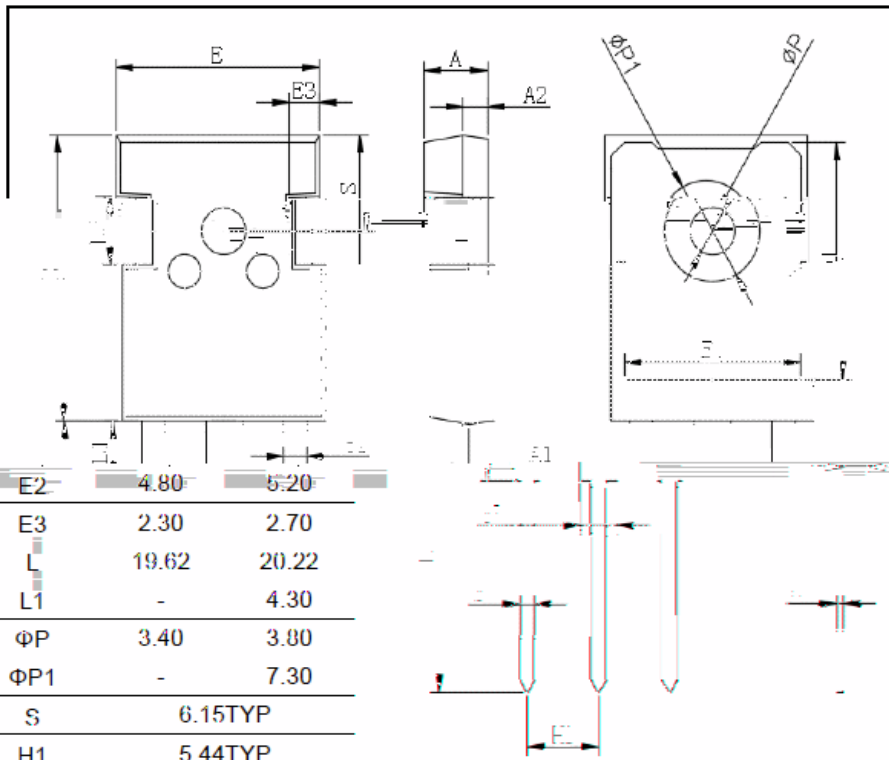

Figure 8. Transient Thermal Impedance



TO-247AB		
Dim	Min	Max
A	4.80	5.20
A1	2.21	2.61
A2	1.85	2.15
lb	1.0	1.4
b2	1.91	2.21
C	0.5	0.7
D	20.70	21.30
D1	16.25	16.85
E	15.50	16.10
E1	13.0	13.6

E2	4.80	5.20
E3	2.30	2.70
L	19.62	20.22
L1	-	4.30
ΦP	3.40	3.80
ΦP1	-	7.30
S	6.15TYP	
H1	5.44TYP	
b3	2.80	3.20



The information presented in this document is for reference only. Yangzhou Yangjie Electronic Technology Co., Ltd. reserves the right to make changes without notice for the specification of the products displayed herein to improve reliability, function or design or otherwise.

The product listed herein is designed to be used with ordinary electronic equipment or devices, and not designed to be used with equipment or devices which require high level of reliability and the malfunction of which would directly endanger human life (such as medical instruments, transportation equipment, aerospace machinery, nuclear-reactor controllers, fuel controllers and other safety devices), Yangjie or anyone on its behalf, assumes no responsibility or liability for any damages resulting from such improper use of sale.

This publication supersedes & replaces all information previously supplied. For additional information, please visit our website [http:// www.frxelec.com](http://www.frxelec.com) , or consult your nearest Yangjie's sales office for further assistance.