



# 深圳市弗瑞鑫电子有限公司

## 规格承认书

—  
——  
——

prepare	
check	
approve	



TRX电容一级代理商

深圳市弗瑞鑫电子有限公司

Add: 深圳市宝安区西乡大道302号金源商务大厦B座3楼

Tel: 0755-29563634

Fax: 0755-27447020





- 2 2 . .			
/		/	
/		/	

	- 2 2 . .		
	/		/
	/		/

1. /

$\overline{\text{①}}$   $\overline{\text{②}}$   $\overline{\text{③}}$   $\overline{\text{④}}$   $\overline{\text{⑤}}$   $\overline{\text{⑥}}$

①

	- 2 2 . .		
	/		/
	/		/

3. /



4. /

5. /

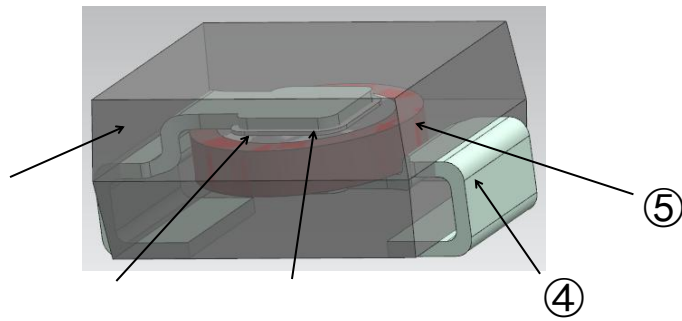

①		
②		
③		
④		
⑤		

- 2  
2 ..

/ /  
/ 5 /

 <b>TRX</b> 专注电容器廿年	- 2 2 . .		
	/		/
	/		/

/

°  
°C

°

°

°

/

7. /



	- 2 2 . .		
	/		/
	/		/





- 2  
2 ..

/

/

/

/

					±
		±			
		±			
		±			
		±			





# TRX

专注电容器廿年

- 2  
2 . .

/

/

/

/

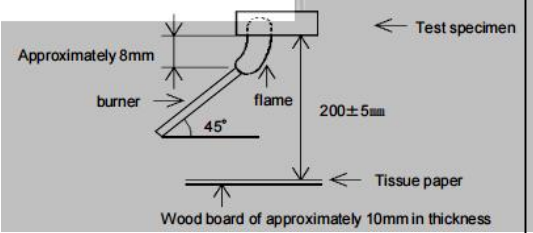

			± ±
			± ±
			± ±

8. /

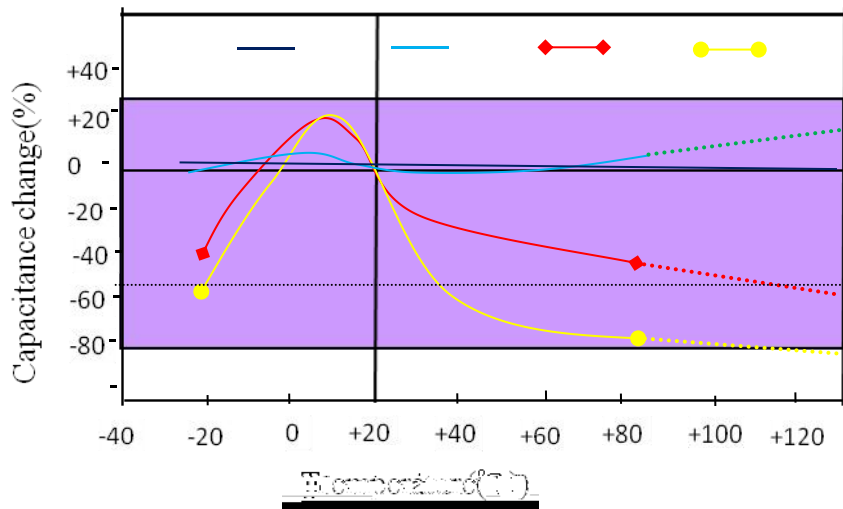

 <b>TRX</b> 专注电容器廿年	- 2 2 ..		
	/		/
	/		/

9. /







10. /

(1)

(2)

/  
/

(3)

(4)

x

11. /  
/

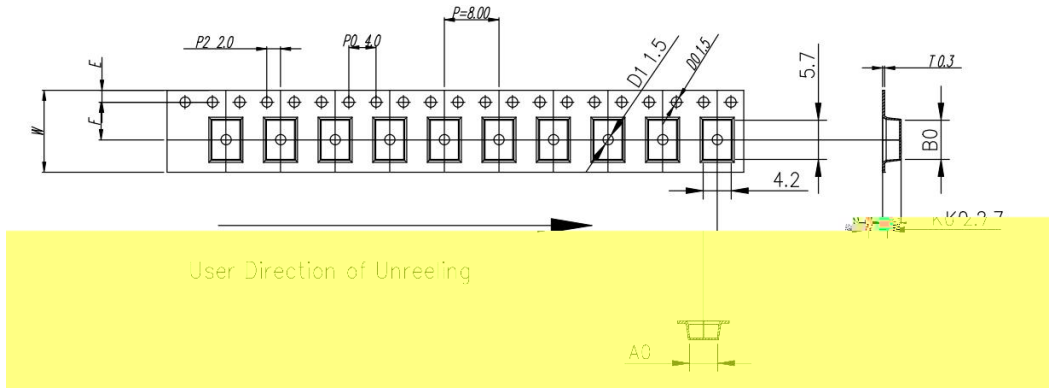



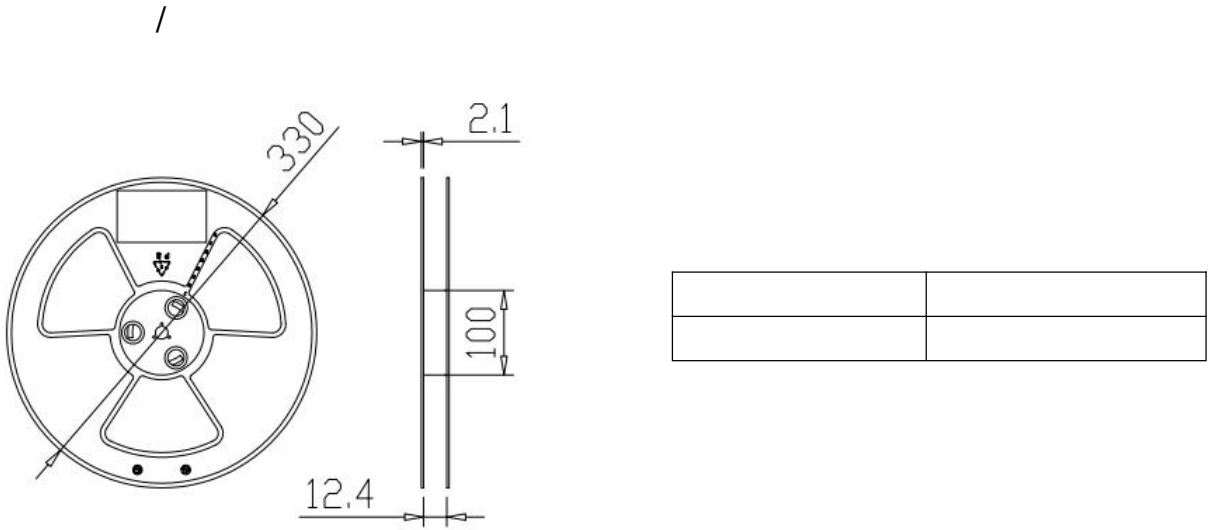

ITEM	W	A0	B0	K1	K0	P	F	E	D0	D1	P0	P2	T
DIM	12.0	$4.0 \pm 0.30$	$5.70 \pm 0.10$	--	$2.70 \pm 0.10$	$8.00 \pm 0.10$	$5.50 \pm 0.10$	$1.75 \pm 0.10$	$\phi 1.5 \pm 0.05$	$\phi 1.5 \pm 0.10$	$4.0 \pm 0.10$	$2.0 \pm 0.10$	$0.30 \pm 0.05$
ALTERNATE													



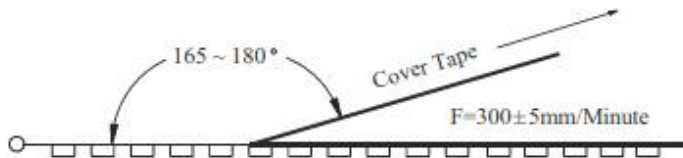

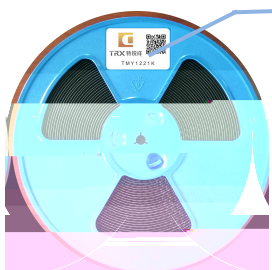

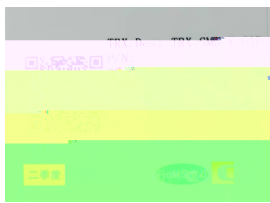
/

Item	Data	Remark
Cover tape adhesion	10 ~ 100g	Carrier tape and cover tape open angle 165 ~ 180° F=300±5mm/minute



/ -	 <p style="margin-left: 10px;">标签</p>  <p style="margin-left: 10px;">料号</p>	
/ -	  	

	 	
图示 /	图示 /	图示 /

/ :			
/	/	/	/
			

" "



	- 2 2 . .		
	/		/
	/		/

12. /

①

②