

## 规格承认书

—

\_\_\_\_\_

\_\_\_\_\_

prepare	
check	
approve	



TRX电容一级代理商  
深圳市弗瑞鑫电子有限公司

Add: 深圳市宝安区西乡大道302号金源商务大厦B座3楼

Tel: 0755-29563634

Fax: 0755-27447020

 <b>TRX</b> 专注电容器廿年	- 2 2 . .			
	/	-3-082	/	2021-11-15
	/	A1	/	P 3 18

1/

/

CODE	C OME P.N.	P.N.	P	P
1	/	B 2220K L	MD- 2 L220K/AC300	4335
2	/	B 2470K L	MD- 2 L470K/AC300	4335
3	/	B 2680KB	MD- 2 5P680K/AC300	4335
4	/	B 2101KB	MD- 2 5P101K/AC300	4335
5	/	B 2221KB	MD- 2 5P221K/AC300	4335
6	/	B 2331KB	MD- 2 5P331K/AC300	4335
7	/	B 2471ME	MD- 2 5 471M/AC300	4335
8	/	B 2681ME	MD- 2 5 681M/AC300	4335
9	/	B 2102ME	MD- 2 5 102M/AC300	4335
10	/	B 2152MF	MD- 2 5 152M/AC300	4335
11	/	B 2222MF	MD- 2 5 222M/AC300	4335
		L CLA I	5P/ 5 / 5	CLA II

2/

- 2.

2

2 AC

.C	22	47	68	100	220	330	470	680	1000	1500	2200
L											
2B( 5P)											
2E( 5 )											
2F( 5 )											
	300 .										
o	-40 125										
C	40/ 125/ 21										

1000

100H

A AC

..

1000 . ,

100H .

..

 <b>TRX</b> 专注电容器廿年	- 2 2 . .			
	/	-3-082	/	2021-11-15
	/	A1	/	P 4 18

## /CON EN

1.	P	N	-----	5
2.	P		-----	5-6
3.	D		-----	6
4.	C		-----	7
5.	P		-----	7-8
6.			-----	8-9
7.	P		-----	9-14
8.	C		-----	14
9.	C		-----	15
10.			-----	15
11.	P	P	-----	16-17
12.	A		-----	18

 <b>TRX</b> 专注电容器廿年	- 2 2 . .			
	/	-3-082	/	2021-11-15
	/	A1	/	P 5 18

1. /

① ② ③ ④ ⑤ ⑥

N .	C	E
①		L L
②	B	P (4335) (4335)
③	2	
④	102	C  ( : 102=10× 10 <sup>2</sup> =1000 F)
⑤	M	/C K( 10%) / M( 20%)
⑥	E	/ D L -55 +85 +350 1000 / B( 5P) -30 +85 ± 10% E( 5 ) -30 +85 22%/-56% F( 5 ) -30 +85 22%/-82%

!

2. /

M	 <b>TRX</b> <b>TL E 102M</b> <b>X1 440V~</b>
---	---

 <b>TRX</b> 专注电容器廿年	- 2 2 . .			
	/	-3-082	/	2021-11-15
	/	A1	/	P 6 18

3. /



		2020	M	1	01	1	01	16	16
		2021	N	2	02	2	02	17	17
2010	A	2022	P	3	03	3	03	18	18
2011	B	2023		4	04	4	04	19	19
2012	C	2024		5	05	5	05	20	20
2013	D	2025		6	06	6	06	21	21
2014	E	2026		7	07	7	07	22	22
2015	F	2027		8	08	8	08	23	23
2016	H	2028		9	09	9	09	24	24
2017	J	2029		10	10	10	10		

4. /

C		C	C
L/C L	L/C A 60384-14	E315719	AC300 ( . . . )
C C	GB/ 6346.14-2015	C C20001280609	AC300 ( . . . )
ENEC	EN 60384-14:2013/A1:2016	ENEC-03177	AC300 ( . . . )
KC	K60384-14	H 03034-21003A	AC250 ( . . . )

5. /

5.1 /P D

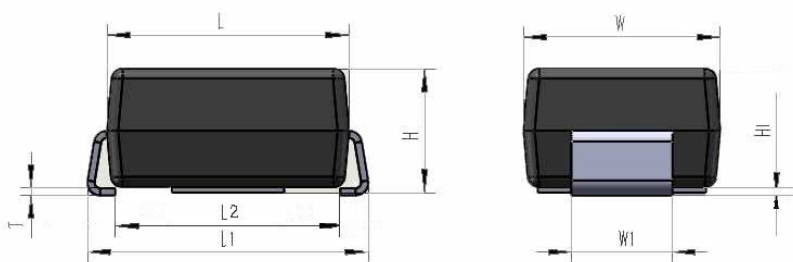

P		D		( )	
L	4.3 0.1			3.5 0.3	
L1	5.0 0.1	L2		4.0 0.1	
H	2.2 0.1	1		1.8 0.05	
H1	0.1 0.05			0.13 0.02	

5.2 /P

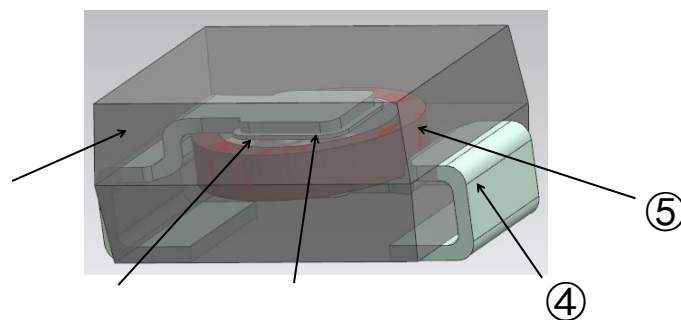

N .	P	M
①	C	E ( L94 -0) ( L94 -0)
②	E	/C
③		-P -A -P -A
④	L P	
⑤	D	C

- 2

2 . .

/

-3-082

/

2021-11-15

/

 <b>TRX</b> 专注电容器廿年	- 2 2 . .			
	/	-3-082	/	2021-11-15
	/	A1	/	P 9 18

6.2 /F

280 °  
280°C .

30 °  
30 .

200 °  
200 .

P 200 .

180 °  
180 .

6.3 / I  
PCB/P B

PCB/P B,

400  
- 400 .

50  
50 .

5  
5 .

7. /

NO	I		
1	A	N L L	
2	D	5.1 5.1	



	- 2 2 . .			
	/	-3-082	/	2021-11-15
	/	A1	/	P 10 18

NO	I	
----	---	--



- 2 2 . .			
/	-3-082	/	2021-11-15
/	A1	/	P 11 18

NO	I		
8			150 180 C 90 30 P 150 180 C 90 30 . / . : 230 C-260 C / : 60± 15 . / :4 15--35 45--75% H 24 2 L 15-35 , 45-75% H 24 2 , .
		NO.3 P NO.3	
	C	L:± 10% 5P:± 10% 5 :± 20% 5 :± 20%	
	D.F.	L: 1.0% 5P: 2.5% 5 : 2.5% 5 : 2.5%	
	I .	NO.7 P NO.7	
9		G	( 90% ) 3 ( 90%), 3 I (JI K 5902) (JI K 8101) 25%) ( ) 5902) (25%) (JI K 8101) (JI K ) . ( ) I 2 0.5 2 0.5 . : 245 10 C
10		N	
		NO.3 P NO.3	: +125 3
	C	L:± 10% 5P: 10% 5 : 20% 5 : 20%	: -40 3 / : 5
	D.F.	L: 1.0% 5P: 2.5% 5 : 2.5% 5 : 2.5%	30 25 3 24 2
	I .	NO.7 P NO.7	C 25 3 24 2 .







 <b>TRX</b> 专注电容器廿年	- 2 2 . .			
	/	-3-082	/	2021-11-15
	/	A1	/	P 14 18

NO	I		
16	C	N P NO.3 NO.7 N .3 N .7	$30 \pm 5\%$ $70 \pm 5\%$ $30 \pm 5\%$ $70 \pm 5\%$ / $23.5$ $5 \pm 0.5$ $5 \pm 0.5$ / $8$
17			$30 \pm 5\%$ $70 \pm 5\%$ $30 \pm 5\%$ $70 \pm 5\%$ / $23.5$ $5 \pm 0.5$ $10$ $5 \pm 0.5$ $10$

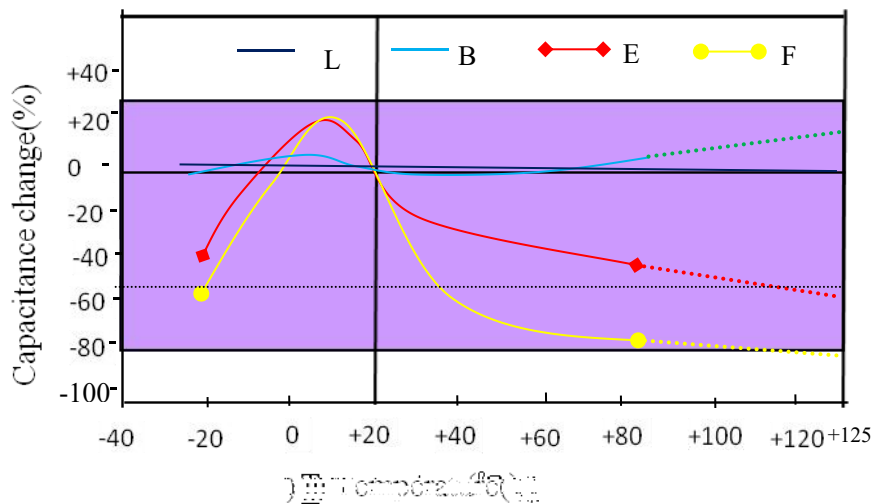
8. /



 <b>TRX</b> 专注电容器廿年	- 2 2 . .			
	/	-3-082	/	2021-11-15
	/	A1	/	P 15 18

9. /

H 2.0 2011/65/E

EACH N 190 7/2006



	( ; )
/C	<100
/L	<1000
/M	<1000
/H	<1000
PBB /P	<1000
PBDE /P	<1000
+ + + /C +P +H +C +6( )	<100
/C	<900
/B	<900
+ /C +B	<1500
EACH HC H C ( HC) EACH	EACH

10. /

(1).

E ; , , , ,  
 . A , , , , , ,

(2).

12 , 12

(3).

/ : 10 30  
 /H : 60% .  
 168

(4).

6 168 HIC - . A  
 60 × 168 I 6 HIC  
 , (60 168 ) .

 <b>TRX</b> 专注电容器廿年	- 2 2 . .			
	/	-3-082	/	2021-11-15
	/	A1	/	P 16 18

11. /  
11.1 /D

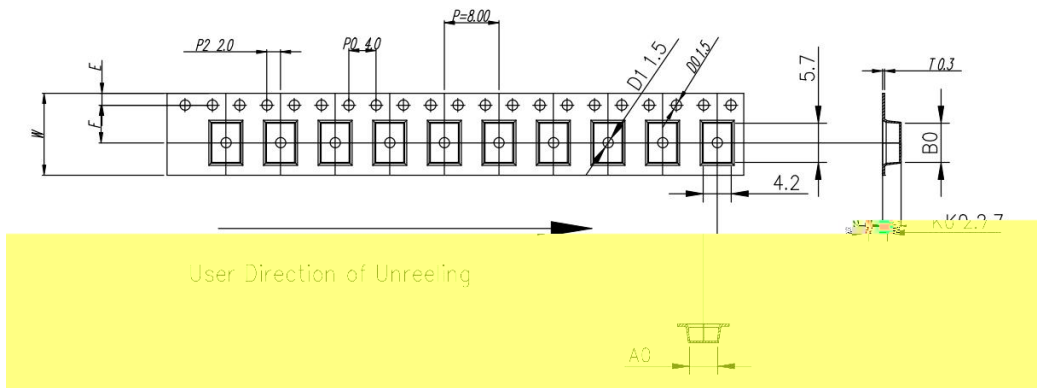

ITEM	W	A0	B0	K1	K0	P	F	E	D0	D1	P0	P2	T
DIM	12.0	$4.38^{+0.10/-0.30}$	$5.70^{+0.10/-0.10}$	--	$2.70^{+0.10/-0.10}$	8.00	$5.50^{+0.10/-0.10}$	1.75	$\phi 1.5^{+0.10/-0.10}$	$\phi 1.5^{+0.10/-0.10}$	4.0	2.0	0.30
ALTERNATE													

11.2 /D

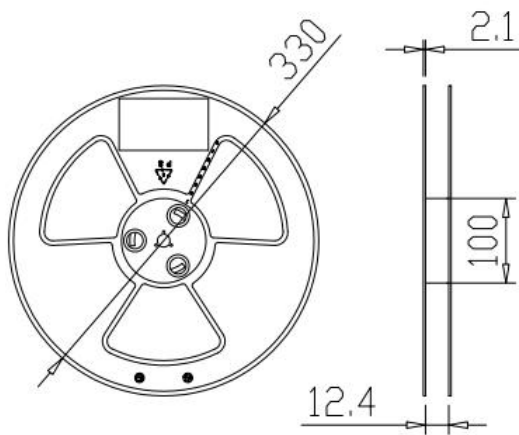

EEL	EEL I E
3000	13



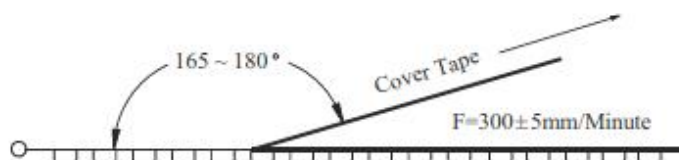

11.3 /P



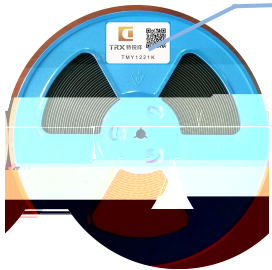

Item	Data	Remark
Cover tape adhesion	10 ~ 100g	Carrier tape and cover tape open angle 165 ~ 180° F=300±5mm/minute

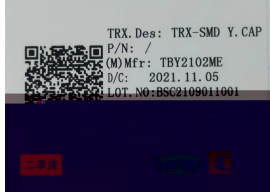

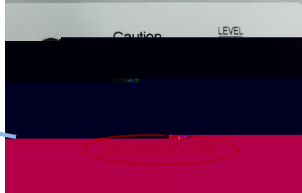

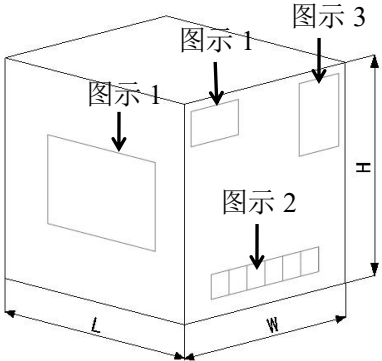

 <b>TRX</b> 专注电容器廿年	- 2 2 . .			
	/	-3-082	/	2021-11-15
	/	A1	/	P 17 18

11.4 /P P

/ -	 标签/L  料号 : 13 3.0KPC /		/I	/I
/P				.D
				P/N
				M
				D/C
				L .N
				PEC

/ -				
	图示 1/F 1	图示 2/F 2	图示 3/F 3	
	D ( )			O B
	L	H	45KPC	10.0KG
	355	294		

/	:				
/O B	15 / /15 /B			( / / ) P (L/ /H) 1100*1100*90	( / / ) (L/ /H) 1100*1100*1600

1. " 5" 5 2. PALLE & APPING  
 3.50 :1. 5 ; 3.50 ' 5 ; 2. P & -  
 / ; 3.50 ; 4. N



	- 2 2 . .			
	/	-3-082	/	2021-11-15
	/	A1	/	P 18 18

12. /

①.

A

②.

PCB

PCB

PCB

C

(PCB)

PCB

PCB

□

□