



深圳市弗瑞鑫电子有限公司

规格承认书

—
——
——

prepare	
check	
approve	



TRX电容一级代理商
 深圳市弗瑞鑫电子有限公司

深圳市宝安区西乡大道302号金源商务大厦B座301
 0755-29563634
 0755-27447020



/ . .



/ . .

! /

!

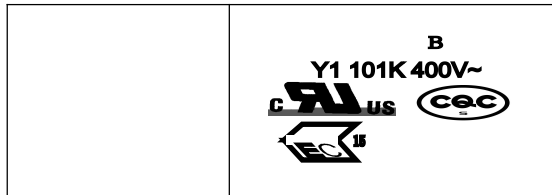

	/ . .			



.

.

.

.

-

. .

-

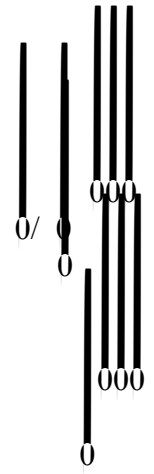

()					

/ ..			

			<p style="text-align: right;">000+ /-0</p>												
		(- 0) / 0 0%	<p>0. 0. 000</p>												
		000	0.												
		(- 0) / 0 0%	<p style="text-align: right;">%. %</p>												
		000 (- 0) / 0 0%	<p>0 () 0000</p>												
		000 (- 0) / 0 0%	<p style="text-align: center;">0 0</p>												
			<table border="1" style="width: 100%; text-align: center;"> <tr> <td style="width: 33%;">00</td> <td style="width: 33%;">0</td> <td style="width: 33%;">0</td> </tr> <tr> <td>00</td> <td>0</td> <td>0</td> </tr> <tr> <td>00</td> <td>0</td> <td>0</td> </tr> <tr> <td>0</td> <td>0</td> <td>0</td> </tr> </table>	00	0	0	00	0	0	00	0	0	0	0	0
00	0	0													
00	0	0													
00	0	0													
0	0	0													

/ . .			

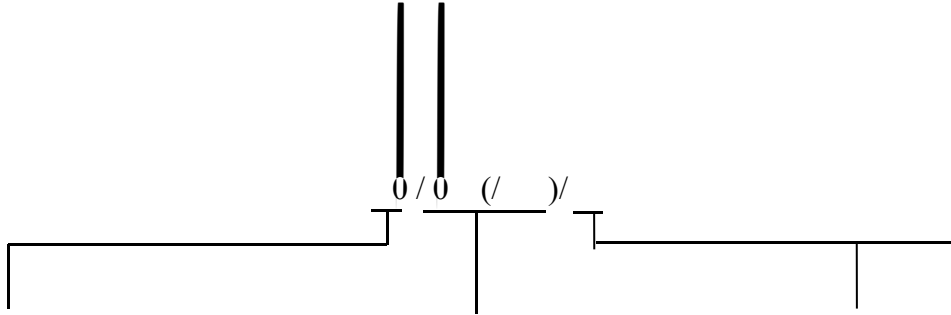

()
 ()
 ()

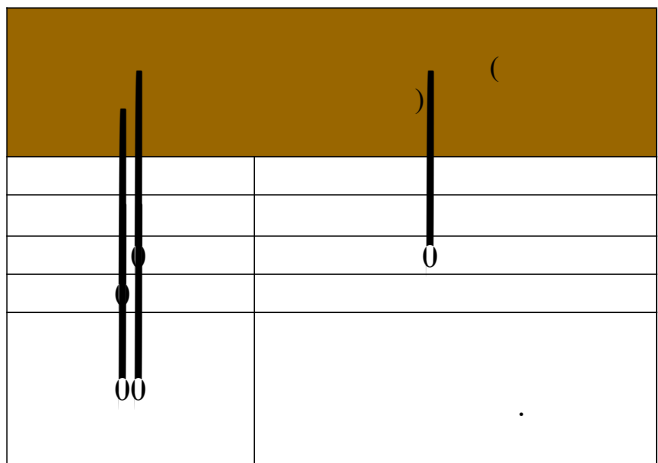
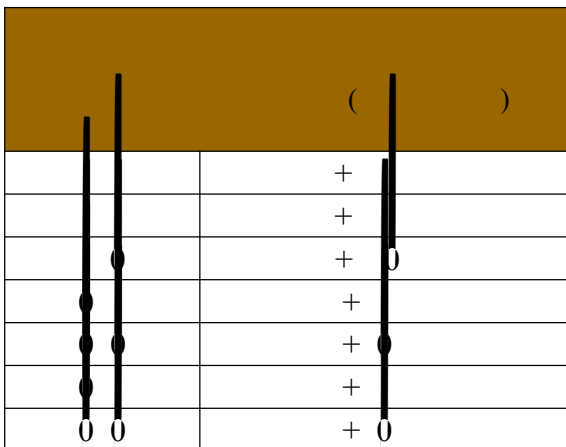
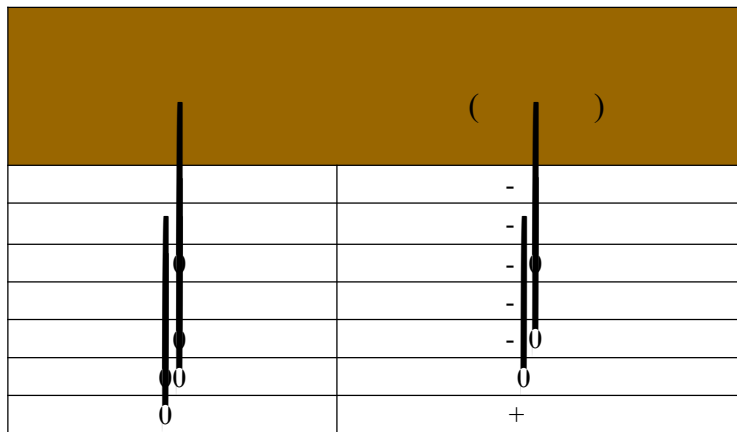
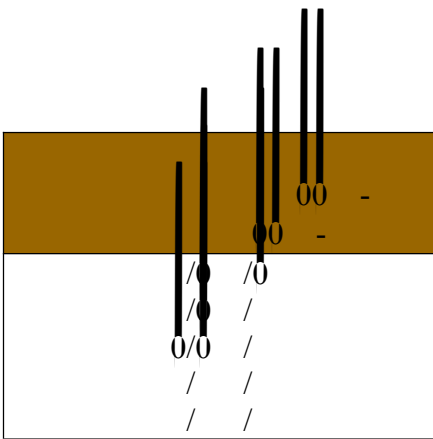

/ ..			

.0 0 / /
 0 / 00



)	
	00
	00
	00
	00
	00
	00
+ + + + () + + +	00
	00
+ +	00
()	000

	/ . .			



/ . .			

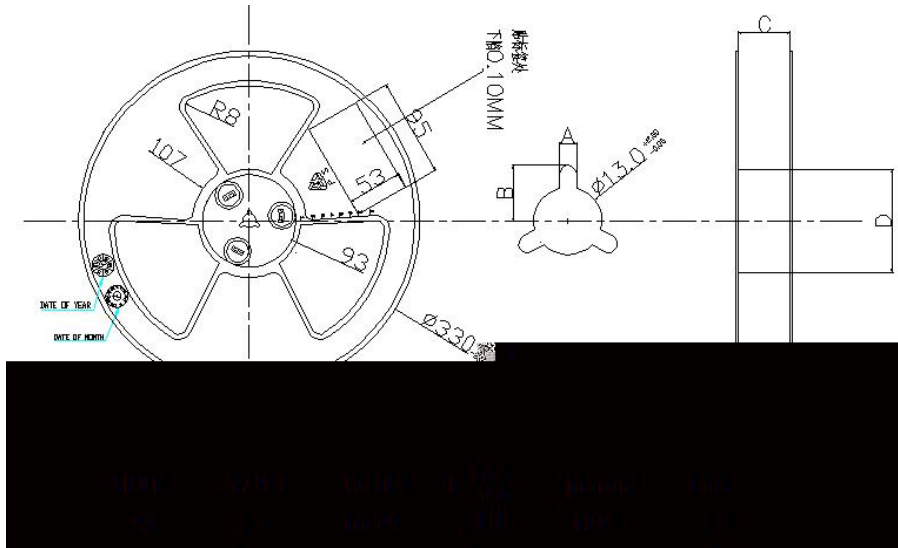
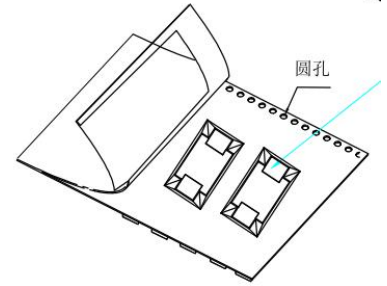
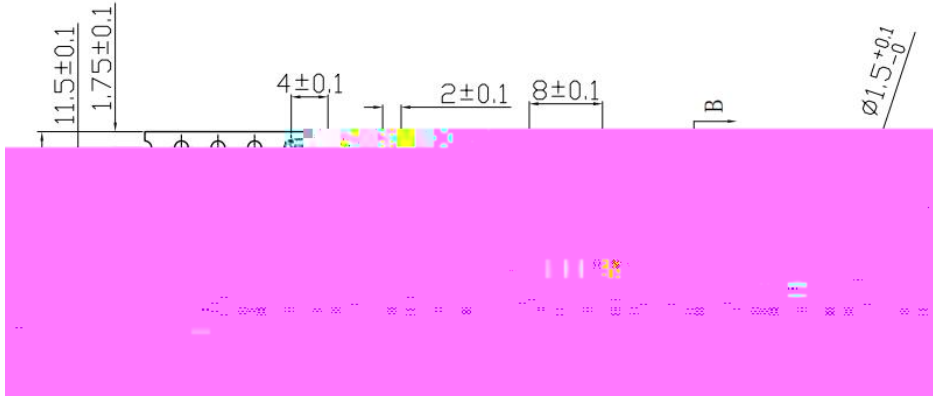

Item	Data	Remark
Cover tape adhesion	10 ~ 100g	Carrier tape and cover tape open angle 165 ~ 180° F=300±5mm/minute

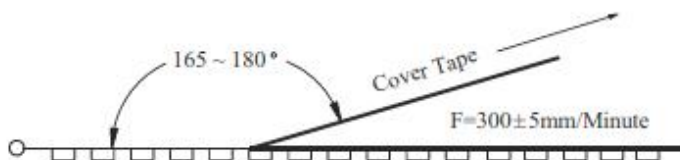

/ . .			

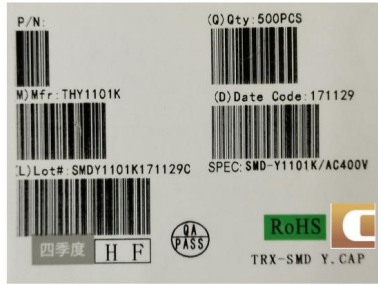

	/
	#

.0 /

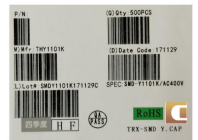
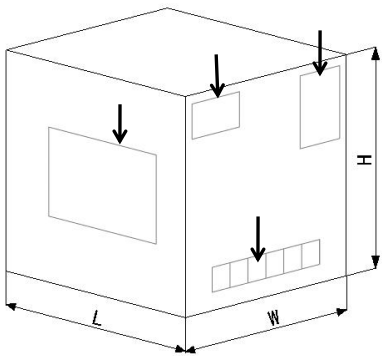

()				
			0	0.



|

| | | | |
 00* 00* 0 (/ /)

| | | | |
 00* 00* / 00)

&

|

&

-

/

|

	/ . .			

..

..

..

.

.....

.

.

....

..

,

,

(REHU) RMH EDLL UHW LGHW KH



	/ . .			

()

,

.

.

.

,

.



TRX 特锐祥

专 注 电 容 器 11 年

/ . .			

0 - 00

0 - 00

/ . (0 - -)

/ - 00 (0 -) -

/ . - 00 (-) -

() -

()

/ - ()

/ - ()

/ - 00

0 / / (.0)

00 / / ()

/ / 00 / 0/ / / 0

0 / 00 () , , ()